

## FITTINGS

We offer a wide and diverse selection of fittings to meet your system requirements. A “fitting” refers to a complete product ready to assemble and connect tubing into a part. This could be a one-piece connector or a nut and ferrule packaged together. A “Nut” indicates the male or female threaded product sold separately, and a “Ferrule” is sold separately when indicated in the description. For your convenience we ship most Fittings and Ferrules in 10-packs. We are dedicated to providing the most reliable, proven products on the market. We have implemented more stringent testing protocols and a generous safety margin to our ratings to ensure your safety.

**32** CONED FITTINGS

**39** FLAT-BOTTOM FITTINGS

**48** MARVELX™

**50** FITTINGS TOOLS

**56** LARGE BORE FITTINGS

**57** VHP FITTINGS

**61** FITTINGS KITS



## NOTE

All testing is performed with water at room temperature unless otherwise specified. Please contact IDEX Health & Science directly for further details. Results may vary depending on the material of the receiving port and tubing, actual tubing diameters (with stated tolerances), temperature and solvents used. If a pressure range is listed for a product's specification, the pressure rating depends on the tubing material used. The lower end of the range will represent testing performed on softer tubing such as FEP, and the higher end of the range will represent testing performed on harder tubing such as Stainless Steel. For more detail, please see the product specification sheets on our website, [www.idex-hs.com](http://www.idex-hs.com), or contact us directly.



## APPLICATION NOTE

### What Threads Do I Have?

Hold your fitting over the thread silhouettes below to identify the threads.

#### U.S. CUSTOMARY THREADS

6-40



6-32



10-32



1/4-28



5/16-24



1/2-20



#### METRIC THREADS

M4 x 0.7



M6 x 1





# One-Piece Fingertight Fittings

- › The original One-Piece Fingertight Fitting
- › All polymer construction
- › Versions available for 1/16", 1/32" or 1/8" OD tubing
- › Convenient and easy to use
- › Reusable

## NOTE

- › Some of the fittings on this page are available in additional colors. Please contact your distributor or us for more information.
- › Fingertight is generally equal to 3–4 in-lbs (0.34–0.45 N·m).

Our One-Piece Fingertight Fittings provide convenience and ease of use because the ferrule will not stick in a receiving port and the fitting is more easily found if dropped. The fittings for 1/16" OD tubing and 10-32 coned ports are available in a variety of colors, materials and lengths to suit virtually every application.

Beyond the standard 10-32 fittings, also featured in this product family are specialty fittings for specific applications. Our M-645 Fitting is a direct replacement for the 6-40 threaded VICI® (Valco) fitting. The P-100 can be used in 1/4-28 coned ports for 1/8" OD tubing including some of the inlet filters starting on page 102.

RheFlex® One-Piece Fittings are included in many of the manual valves, starting on page 121. The One-Piece RheFlex M4 Fittings, for use with our MX Nano-Scale Modules, are listed on page 61.

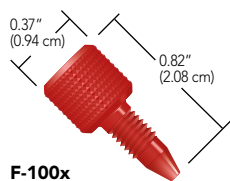

**F-100x**  
10-32 PCTFE Fitting

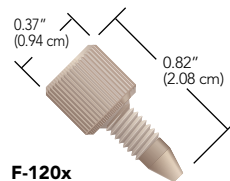

**F-120x**  
10-32 PEEK Fitting

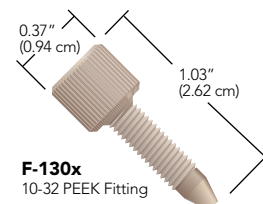

**F-130x**  
10-32 PEEK Fitting

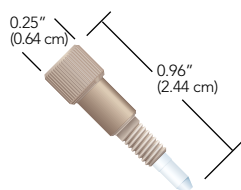

**M-645x**  
6-40 PEEK/PCTFE Fitting  
for 1/32" OD tubing

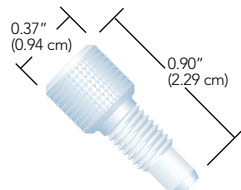

**P-100**  
1/4-28 PCTFE Fitting  
for 1/8" OD tubing

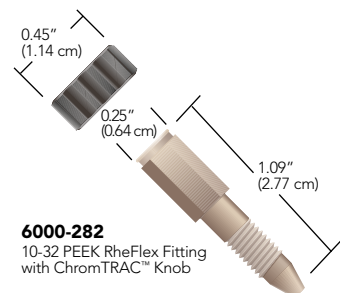

**6000-282**  
10-32 PEEK RheFlex Fitting  
with ChromTRAC™ Knob

Part No.	Description	Port	Pressure Rating	Head Style	Material	Qty.
<b>ONE-PIECE FINGERTIGHT FITTINGS</b>						
<b>6000-282</b>	Fingertight Fitting for 1/16" OD Tubing	10-32 Coned	5,000 psi (345 bar)	ChromTRAC knob	PEEK, Natural	10-pk
<b>F-100x</b>	Fingertight Fitting for 1/16" OD Tubing	10-32 Coned	4,000 psi (276 bar)	Diamond Knurl	PCTFE, Red	10-pk
<b>F-120x</b>	Fingertight Fitting for 1/16" OD Tubing	10-32 Coned	5,000 psi (345 bar)	Standard Knurl	PEEK, Natural	10-pk
<b>F-130x</b>	Fingertight Fitting for 1/16" OD Tubing, Long	10-32 Coned	5,000 psi (345 bar)	Standard Knurl	PEEK, Natural	10-pk
<b>M-645x</b>	Fingertight Fitting for 1/32" OD Tubing	6-40 Coned	1,750–3,250 psi (121–224 bar)	Headless Knurl	PEEK, Natural/PCTFE, Natural	10-pk
<b>P-100</b>	Fingertight Fitting for 1/8" OD Tubing	1/4-28 Coned	1,000 psi (69 bar)	Diamond Knurl	PCTFE, Natural	ea.



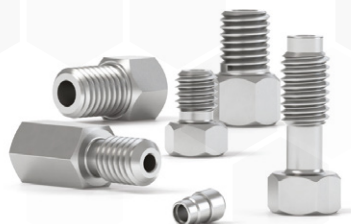

# Stainless Steel Fittings

## NOTE

- Do not use metal fittings in plastic ports, as this can damage the port.
- The recommended torque to tighten these fittings is 20 in-lbs (2.25 N·m).

These 316 Stainless Steel Fittings are rated to 20,000 psi (1,380 bar) when wrench tightened. Choose IDEX Health & Science standard fittings, or select from the Common Valve Fittings or other manufacturer-compatible offerings.

## Standard Stainless Steel Fittings

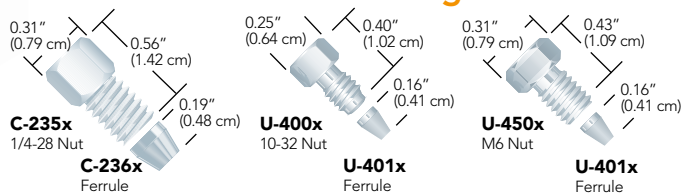

## Common Valve Fittings

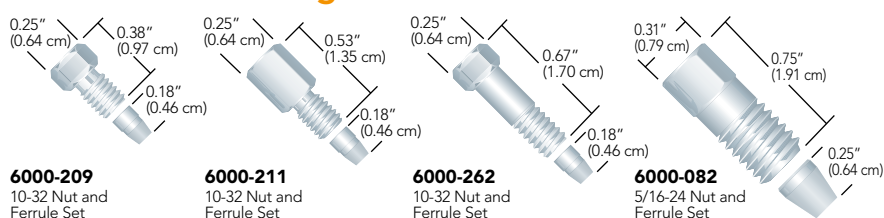

## Beckman® Compatible Fittings

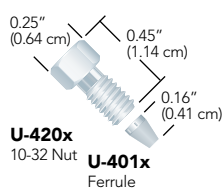

## VICI® (Valco) Compatible Fittings

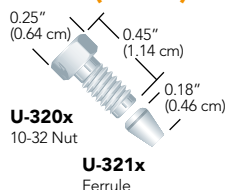

Part No.	Description	Port	Pressure Rating	Head Style	Material	Qty.
<b>STANDARD STAINLESS STEEL FITTINGS</b>						
C-235x	Nut for 1/8" OD Tubing	1/4-28 Coned	20,000 psi (1,380 bar)	5/16" Hex	SST	10-pk
C-236x	Ferrule for 1/8" OD Tubing	1/4-28 Coned	20,000 psi (1,380 bar)	—	SST	10-pk
U-400x	Nut for 1/16" OD Tubing	10-32 Coned	20,000 psi (1,380 bar)	1/4" Hex	SST	10-pk
U-401x	Ferrule for 1/16" OD Tubing	10-32 or M6 Coned	20,000 psi (1,380 bar)	—	SST	10-pk
U-450x	Nut for 1/16" OD Tubing	M6 Coned	20,000 psi (1,380 bar)	5/16" Hex	SST	10-pk
<b>COMMON VALVE FITTINGS</b>						
6000-082	Fitting for 1/8" OD Tubing	5/16-24 Coned	20,000 psi (1,380 bar)	5/16" Hex	SST	ea.
6000-083	Ferrule for 1/8" OD Tubing	5/16-24 Coned	20,000 psi (1,380 bar)	—	SST	5-pk
6000-209	Fitting for 1/16" OD Tubing	10-32 Coned	20,000 psi (1,380 bar)	1/4" Hex	SST	10-pk
6000-210	Ferrule for 1/16" OD Tubing	10-32 Coned	20,000 psi (1,380 bar)	—	SST	10-pk
6000-211	Fitting for 1/16" OD Tubing, Long	10-32 Coned	20,000 psi (1,380 bar)	1/4" Hex	SST	10-pk
6000-262	Fitting for 1/16" OD Tubing, Extra Long	10-32 Coned	20,000 psi (1,380 bar)	1/4" Hex	SST	10-pk
<b>MANUFACTURER COMPATIBLE FITTINGS</b>						
U-320x	Nuts for 1/16" OD Tubing, Valco/VICI Compatible	10-32 Coned	20,000 psi (1,380 bar)	1/4" Hex	SST	10-pk
U-321x	Ferrule for 1/16" OD Tubing, Valco/VICI Compatible	10-32 Coned	20,000 psi (1,380 bar)	—	SST	10-pk
U-410x	Nuts for 1/16" OD Tubing, Waters Compatible	10-32 Coned	20,000 psi (1,380 bar)	5/16" Hex	SST	10-pk



# MicroTight® Fittings

- › Comprehensive Fitting System for Connecting Capillary Tubing
- › Made from PEEK Polymer

MicroTight® One-Piece Fittings are designed for use with the NanoPort™ and MicroTight Unions, Adapters and Inline MicroFilters. Specifically made for 360 µm OD tubing, 1/32" OD tubing, or our MicroTight Tubing Sleeves (see page 52), these fittings make superior fingertight connections with capillary tubing. MicroTight Fittings withstand temperatures up to 125 °C.

The MicroTight family also includes a female nut matched with one of five dedicated ferrules for connecting specific tubing ODs.

Use the P-277 Extender Tool to tighten standard micro knurl 6-32 fittings in hard-to-reach places. Tighten micro headless 6-32 fittings with our N-290 Tool. See page 50 for more information.



## NOTE

### MicroTight fittings and MicroFerrules

While the MicroTight Female Nuts may be used with any of the separate MicroFerrules, the MicroFerrules themselves are port-specific and are thus not interchangeable. Additionally, the one-piece MicroTight fittings are also port-specific and should not be exchanged.



**F-1245x**  
Standard Head Fitting  
for use with  
360 µm OD tubing

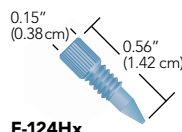

**F-124Hx**  
Headless Fitting  
for use with  
360 µm OD tubing

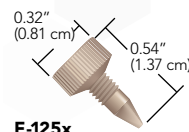

**F-125x**  
Standard Head Fitting  
for use with  
MicroTight Sleeves

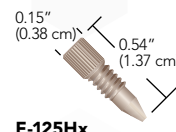

**F-125Hx**  
Headless Fitting  
for use with  
MicroTight Sleeves

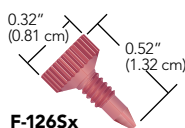

**F-1265x**  
Standard Head Fitting  
for use with 1/32" OD tubing

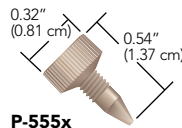

**P-555x**  
Standard Head Plug

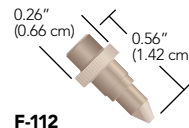

**F-112**  
MicroFerrule for  
1/32" OD tubing



**F-132**  
MicroFerrule for  
1/16" OD tubing

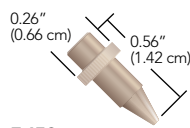

**F-152**  
MicroFerrule for  
360 µm OD tubing

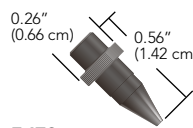

**F-172**  
MicroFerrule for  
0.025" OD tubing

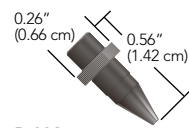

**P-116**  
MicroFerrule Plug

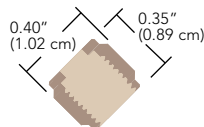

**P-416**  
Female Nut  
5/16-24 internal threads



**P-416BLK**  
Female Nut  
5/16-24 internal threads



**P-416G**  
Female Nut  
5/16-24 internal threads



## RELATED PRODUCTS

- › Connectors for Capillary Tubing can be found on page 75.
- › Very High Pressure fittings for capillary tubing can be found on page 58.
- › Capillary tubing is featured on page 16.

Part No.	Description	Port	Pressure Rating	Head Style	Material	Qty.
<b>MICROTIGHT FITTINGS</b>						
<b>F-124Hx</b>	MicroTight Fitting for 360 µm OD Tubing	6-32 Coned	5,000 psi (345 bar)	Micro Headless Knurl	PEEK Blue	10-pk
<b>F-1245x</b>	MicroTight Fitting for 360 µm OD Tubing	6-32 Coned	5,000 psi (345 bar)	Standard Micro Knurl	PEEK Blue	10-pk
<b>F-125Hx</b>	MicroTight Fitting for MicroTight Tubing Sleeves	6-32 Coned	4,000 psi (276 bar)	Micro Headless Knurl	PEEK Natural	10-pk
<b>F-125x</b>	MicroTight Fitting for MicroTight Tubing Sleeves	6-32 Coned	4,000 psi (276 bar)	Standard Micro Knurl	PEEK Natural	10-pk
<b>F-1265x</b>	MicroTight Fitting for 1/32" OD Tubing	6-32 Coned	5,000 psi (345 bar)	Standard Micro Knurl	PEEK Red	10-pk
<b>P-555x</b>	MicroTight Plug	6-32 Coned	5,000 psi (345 bar)	Standard Micro Knurl	PEEK Natural	10-pk
<b>MICROFERRULES AND FEMALE NUTS</b>						
<b>F-112</b>	MicroFerrule for 1/32" OD Tubing	5/16-24 Coned	5,000 psi (345 bar)	—	PEEK Natural	ea.
<b>F-132</b>	MicroFerrule for 1/16" OD Tubing	5/16-24 Coned	5,000 psi (345 bar)	—	PEEK Natural	ea.
<b>F-152</b>	MicroFerrule for 360 µm OD Tubing	5/16-24 Coned	5,000 psi (345 bar)	—	PEEK Natural	ea.
<b>F-152BLK</b>	MicroFerrule for 360 µm OD Tubing	5/16-24 Coned	5,000 psi (345 bar)	—	PEEK Black	ea.
<b>F-172</b>	MicroFerrule for MicroTight Tubing Sleeves	5/16-24 Coned	4,000 psi (276 bar)	—	PEEK Black	ea.
<b>P-116</b>	MicroFerrule Plug	5/16-24 Coned	5,000 psi (345 bar)	—	PEEK Black	ea.
<b>P-416</b>	MicroTight Female Nut	5/16-24 Coned	4,000–5,000 psi (276–345 bar)	Female Knurl	PEEK Natural	ea.
<b>P-416BLK</b>	MicroTight Female Nut	5/16-24 Coned	4,000–5,000 psi (276–345 bar)	Female Knurl	PEEK Black	ea.
<b>P-416G</b>	MicroTight Female Nut	5/16-24 Coned	4,000–5,000 psi (276–345 bar)	Female Knurl	PEEK Green	ea.



# Two-Piece Fingertight Fittings

- › Designed to connect tubing to 10-32 coned ports
- › Ferrules available for directly connecting 1/16", 1/32", 360 µm, or 190 µm OD tubing
- › Economical, replace only the ferrule



## APPLICATION NOTE

Some Fingertight Nuts feature wings in addition to a knurled head, which provide more leverage when tightening the fitting into a receiving port. Choose our single or double-winged design.

*Please Note: customers can use the standard knurl head fittings with our tightening tools found on page 50.*

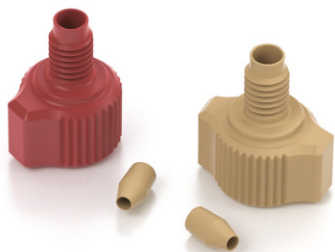

Two-Piece Fingertight Fittings feature a separate ferrule. Use a standard knurled head fitting for traditional fingertight applications, or use a fitting with wings built into the head for extra tightening leverage. A stainless steel hex headed fitting can be used for applications where a wrench may be needed for added tightening torque.

The M-215 Conductive Perfluoroelastomer Ferrule is designed for mass spectrometer electrospray applications. Unlike most graphite ferrules, the elastomeric properties of this ferrule let you use it through many tightening/retightening cycles. It also eliminates any possibility of graphite contamination in your system. Like graphite ferrules, you can apply voltage through a metallic port block or metallic nut, allowing voltage to translate to the flow path through the ferrule.

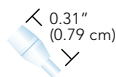

**F-148**  
PCTFE Ferrule  
for 190 µm OD tubing

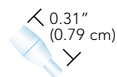

**F-151**  
PCTFE Ferrule  
for 360 µm OD tubing

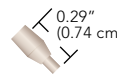

**F-113**  
PEEK Ferrule  
for 1/32" OD tubing

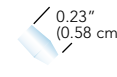

**F-142N**  
ETFE Ferrule  
for 1/16" OD tubing



**M-215**  
Conductive  
Perfluoroelastomer  
Ferrule for 360 µm  
OD tubing

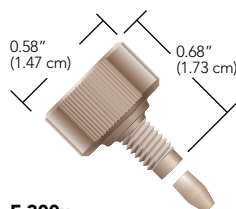

**F-300x**  
10-32 PEEK Double-Winged Nut  
with F-142x PEEK Ferrule

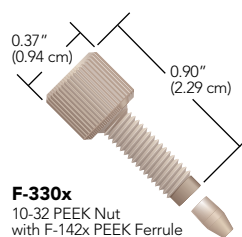

**F-330x**  
10-32 PEEK Nut  
with F-142x PEEK Ferrule

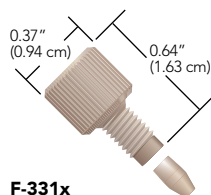

**F-331x**  
10-32 PEEK Nut  
with F-142x PEEK Ferrule

Part No.	Description	Port	Pressure Rating	Head Style	Material	Qty.
<b>TWO-PIECE FINGERTIGHT FITTINGS (INCLUDES F-142 FERRULES)</b>						
<b>F-300x</b>	Fingertight Fitting for 1/16" OD Tubing	10-32 Coned	6,000 psi (414 bar)	Double Wing	PEEK Natural	10-pk
<b>F-330x</b>	Fingertight Fitting for 1/16" OD Tubing, Long	10-32 Coned	6,000 psi (414 bar)	Standard Knurl	PEEK Natural	10-pk
<b>F-331x</b>	Fingertight Fitting for 1/16" OD Tubing	10-32 Coned	6,000 psi (414 bar)	Standard Knurl	PEEK Natural	10-pk
<b>REPLACEMENT FERRULES</b>						
<b>F-113</b>	Ferrule for 1/32" OD Tubing	10-32 Coned	6,000 psi (414 bar)	—	PEEK Natural	ea.
<b>F-142</b>	Ferrule for 1/16" OD Tubing	10-32 Coned	6,000 psi (414 bar)	—	PEEK Natural	ea.
<b>F-142N</b>	Ferrule for 1/16" OD Tubing	10-32 Coned	4,000 psi (276 bar)	—	ETFE Natural	ea.
<b>F-148</b>	Ferrule for 190 µm OD tubing	10-32 Coned	6,000 psi (414 bar)	—	PCTFE Natural	ea.
<b>F-151</b>	Ferrule for 360 µm OD Tubing	10-32 Coned	6,000 psi (414 bar)	—	PCTFE Natural	ea.
<b>M-215</b>	Conductive Ferrule for 360 µm OD tubing	10-32 Coned	1,500 psi (103 bar)	—	Conductive Perfluoroelastomer	ea.



# Two-Piece SealTight™ Fingertight Fittings

- › Several nut lengths and head styles to fit into a variety of applications
- › Designed to connect 1/16" OD tubing to 10-32 coned ports
- › Hold up to 9,000 psi (620 bar)

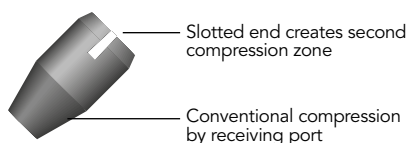

## NOTE

Overtightening these fittings on fluoropolymer (e.g., FEP, PFA, and ETFE) tubing can cause the ID of your tubing to collapse.

## RELATED PRODUCTS

- › Find tightening tools for these fittings on page 50.
- › Try the F-350x FlushNut™ for the ultimate streamline design.

The dual compression created by the specially designed nut and ferrule enables our SealTight™ Fittings system to outperform standard finger tightened fittings. The forward cone of the SealTight Ferrule provides gripping power and a leak-free seal via conventional compression by the receiving port. The slotted end creates the second compression zone in conjunction with a SealTight Nut. All SealTight Nuts are for use with 1/16" OD tubing and are designed to be used with the F-192x Ferrule. A wide variety of fitting head styles are available for various space constraints.

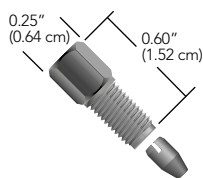

**F-193x**  
10-32 Short PEEK Hex Head Nut, with F-192x Ferrule

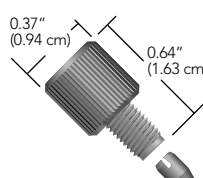

**F-195x**  
10-32 Short PEEK Nut, with F-192x Ferrule

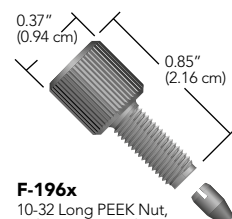

**F-196x**  
10-32 Long PEEK Nut, with F-192x Ferrule

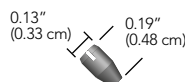

**F-192x**  
SealTight Ferrule, for 1/16" OD tubing

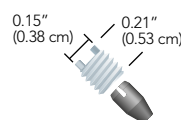

**F-350x**  
10-32 Stainless Steel FlushNut, with F-192x Ferrule

Part No.	Description	Port	Pressure Rating	Head Style	Material	Qty.
<b>SEALTIGHT TWO-PIECE FITTINGS (INCLUDES F-192 FERRULES)</b>						
<b>F-193x</b>	SealTight Fitting for 1/16" OD Tubing, Short	10-32 Coned	7,000–9,000 psi (483–620 bar)	1/4" Hex	PEEK Black	10-pk
<b>F-195x</b>	SealTight Fitting for 1/16" OD Tubing, Short	10-32 Coned	7,000–9,000 psi (483–620 bar)	Standard Knurl	PEEK Black	10-pk
<b>F-196x</b>	SealTight Fitting for 1/16" OD Tubing, Long	10-32 Coned	7,000–9,000 psi (483–620 bar)	Standard Knurl	PEEK Black	10-pk
<b>F-287x</b>	SealTight Fitting for 1/16" OD Tubing, Long	10-32 Coned	7,000–9,000 psi (483–620 bar)	Knurl-1/4" Hex	PEEK Black	10-pk
<b>F-350x</b>	SealTight Fitting for 1/16" OD Tubing, FlushNut	10-32 Coned	7,000–9,000 psi (483–620 bar)	FlushNut	SST	10-pk
<b>REPLACEMENT FERRULES</b>						
<b>F-192x</b>	SealTight Ferrule for 1/16" OD Tubing	10-32 or M6 Coned	7,000–9,000 (483–620 bar)	—	PEEK/Black	10-pk



# NanoTight™ Fittings & Sleeves

- › For connecting 1/16" OD or capillary tubing using tubing sleeves to standard 10-32 coned ports
- › Multiple nut styles available
- › Nuts manufactured from PEEK polymer, ferrules manufactured from ETFE



## RELATED PRODUCTS

- › Find tightening tools for these head styles on page 50.
- › NanoTight Tubing sleeves start on page 52.

NanoTight™ Fittings and Sleeves are designed to connect 70 µm–1 mm OD capillary tubing to any standard 10-32 coned port normally intended for 1/16" OD tubing using the NanoTight Tubing Sleeves on page 52. The fittings can also be used to connect any 1/16" OD tubing. The ETFE ferrule material is softer than PEEK, making it a good candidate for connecting thin walled semi-rigid tubing such as FEP and ETFE into 10-32 ports with minimal constricting to the inner diameter.

Select from our expansive line of PEEK NanoTight Fittings, featuring several head style and length options. Each 10-pack of nuts includes ten ETFE F-142Nx ferrules.

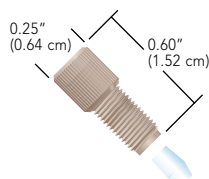

**F-333Nx**  
Short Headless Nut  
with F-142Nx Ferrule

Part No.	Description	Port	Pressure Rating	Head Style	Material (Nut/Ferrule)	Qty.
<b>NANOTIGHT FITTINGS (INCLUDES F-142N FERRULES)</b>						
<b>F-333Nx</b>	NanoTight Fitting for 1/16" OD Tubing and NanoTight Sleeves, Short	10-32 Coned	4,000 psi (276 bar)	Headless Knurl	PEEK Natural/ETFE Natural	10-pk
<b>REPLACEMENT FERRULES</b>						
<b>F-142Nx</b>	NanoTight Ferrule for 1/16" OD Tubing and NanoTight Sleeves	10-32 Coned	4,000 psi (276 bar)	—	ETFE Natural	10-pk

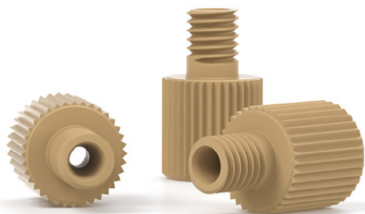

# LiteTouch® Fittings

- › Helps prevent twisting of polymer tubing
- › High pressure with fingertight convenience
- › Options available for 1/32", 1/16", or 1/8" OD tubing

## LITETOUCH FITTINGS SYSTEMS

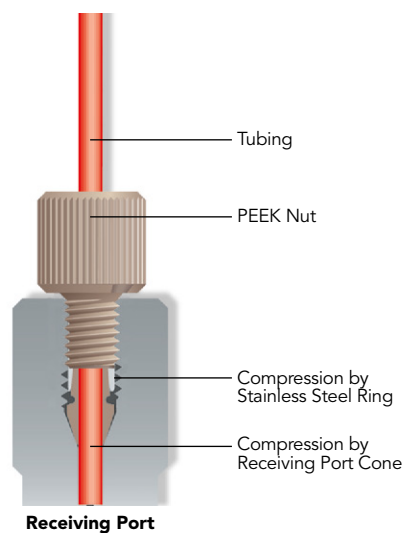

The LiteTouch® Fittings System grips tubing at two compression points (see diagram), holding to high pressures with Fingertight convenience. It also prevents polymer tubing from twisting, a potential problem when using standard Fingertight fittings. LiteTouch Fittings are available for use with 1/32", 1/16", or 1/8" OD tubing sizes, and for 10-32 or 1/4-28 coned ports.

For those space-limited applications where nut heads interfere with each other, try the FlushNut™ Fittings. (FlushNut Fittings require a tightening tool. Please see page 50 for more information about these products.)

To avoid collapsing the ID of your tubing, the LiteTouch system can be used on hard tubing only, such as stainless steel and PEEK polymer tubing. The LiteTouch Ferrule System is not recommended for repeated use in plastic ports.

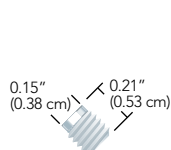

**F-354x**  
10-32 Stainless Steel FlushNut for 1/32" and 1/16" OD tubing

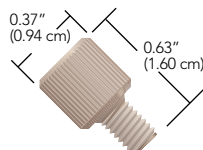

**LT-110x**  
10-32 PEEK Nut for 1/32" and 1/16" OD tubing

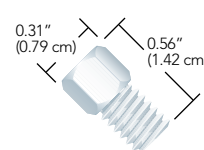

**C-235x**  
1/4-28 Stainless Steel Nut for 1/8" OD tubing

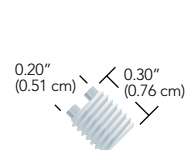

**F-364x**  
1/4-28 Stainless Steel FlushNut for 1/8" OD tubing

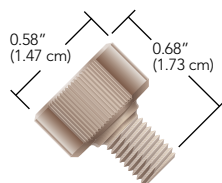

**LT-210x**  
1/4-28 PEEK Double-Winged Nut for 1/8" OD tubing



**LT-132x**  
PEEK Ferrule with Stainless Steel Lock Ring for 1/32" OD tubing

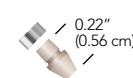

**LT-100x**  
PEEK Ferrule with Stainless Steel Lock Ring for 1/16" OD tubing

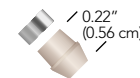

**LT-200x**  
PEEK Ferrule with Stainless Steel Lock Ring for 1/8" OD tubing

## RELATED PRODUCTS

- › The stainless steel nuts on page 59 can also be used with the LiteTouch ferrules on this page.

Part No.	Description	Port	Pressure Rating	Head Style	Material	Qty.
<b>LITETOUCH NUTS</b>						
<b>C-235x</b>	LiteTouch Nut for 1/8" OD Tubing	1/4-28 Coned	4,500 psi (310 bar)	5/16" Hex	SST	10-pk
<b>F-354x</b>	LiteTouch Nut for 1/16" or 1/32" OD Tubing, FlushNut	10-32 Coned	5,000 psi (345 bar)	FlushNut	SST	10-pk
<b>F-364x</b>	LiteTouch Nut for 1/8" OD Tubing, FlushNut	1/4-28 Coned	4,500 psi (310 bar)	FlushNut	SST	10-pk
<b>LT-110x</b>	LiteTouch Nut for 1/16" or 1/32" OD Tubing	10-32 Coned	5,000 psi (345 bar)	Standard Knurl	PEEK Natural	10-pk
<b>LT-210x</b>	LiteTouch Nut for 1/8" OD Tubing	1/4-28 Coned	4,500 psi (310 bar)	Double Wing	PEEK Natural	10-pk
<b>LITETOUCH FERRULES</b>						
<b>LT-100x</b>	LiteTouch Ferrule for 1/16" OD Tubing	10-32 Coned	5,000 psi (345 bar)	—	PEEK Natural/SST	10-pk
<b>LT-132x</b>	LiteTouch Ferrule for 1/32" OD Tubing	10-32 Coned	5,000 psi (345 bar)	—	PEEK Natural/SST	10-pk
<b>LT-200x</b>	LiteTouch Ferrule for 1/8" OD Tubing	1/4-28 Coned	4,500 psi (310 bar)	—	PEEK Natural/SST	10-pk

\* When used with a stainless steel 10-32 nut from page 59.



# Super Flangeless™ Fittings

- › Highest pressure holding flat-bottom fitting system we offer
- › Eliminates loosening of fittings due to tubing twist
- › Excellent for Tubing Assemblies
- › Holds tight even through vibration

## ★ ASSEMBLY HINT

Make sure the locking ring is oriented correctly! The flattened end of the ring should face towards the nut with the narrow end of the ferrule towards the ring.

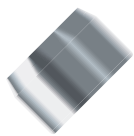

Enlarged to show detail

## 📄 SUPER FLANGELESS FITTINGS SYSTEM

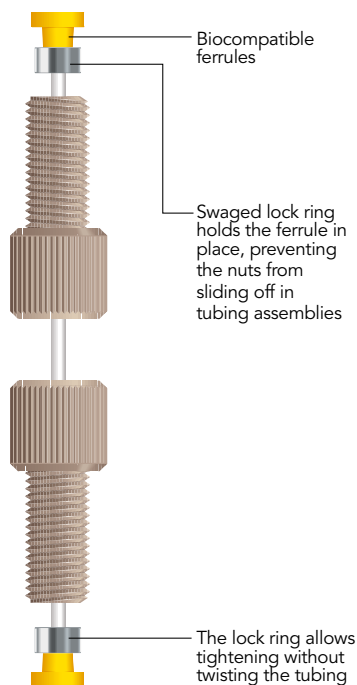

Our Super Flangeless™ Fittings provide the highest pressure holding capability in a flat-bottom fitting system that we offer. Our unique design eliminates loosening of fittings due to tubing twist and holds tight even through vibration. Our high pressure fittings are excellent for tubing assemblies and those times when connections need to be broken frequently.

### 6-40 & 6-32 options (for 1-16" OD tubing)

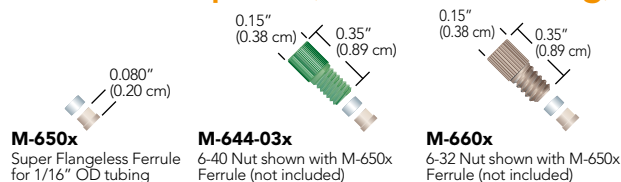

### 10-32 options (for 1-16" OD tubing)

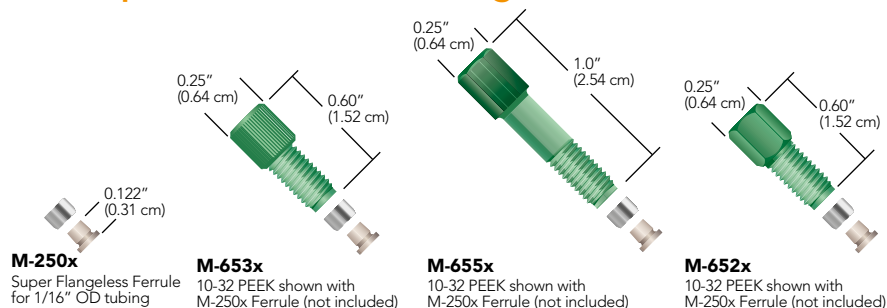

### Ferrules for M6x1, 1/4-28, 5/16-24

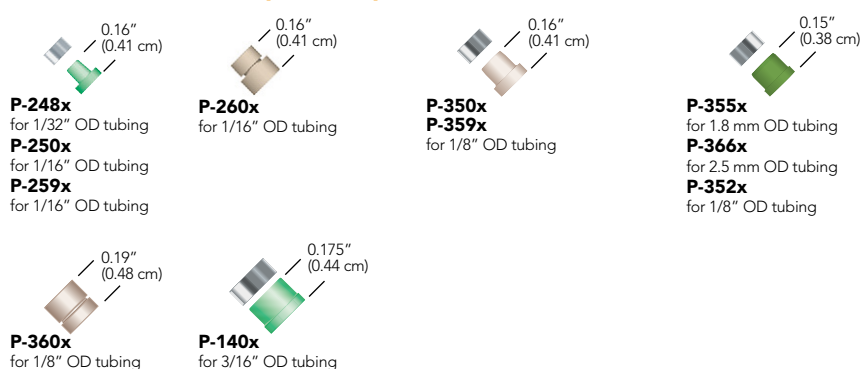



# Super Flangeless™ Fittings (Cont.)

## M6x1, 1/4-28, 5/16-24 Options for 1/32"–3/16" OD Tubing

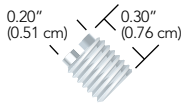

**F-356x**  
(1/4-28, ≤ 1/16" OD Tubing)  
**F-364x**  
(1/4-28, > 1/16" OD Tubing)

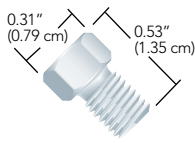

**LT-105x**  
(1/4-28, ≤ 1/16" OD Tubing)  
**C-235x**  
(1/4-28, > 1/16" OD Tubing)

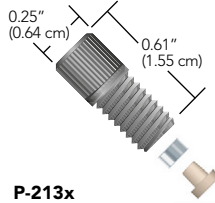

**P-213x**  
(M6X1, ≤ 1/16" OD Tubing)  
**P-337x**  
(M6X1, > 1/16" OD Tubing)  
**P-232x**  
(1/4-28, ≤ 1/16" OD Tubing)  
**P-336x**  
(1/4-28, > 1/16" OD Tubing)

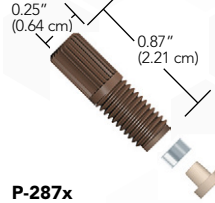

**P-287x**  
(1/4-28, ≤ 1/16" OD Tubing)  
**P-387x**  
(1/4-28, > 1/16" OD Tubing)

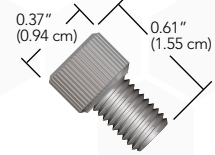

**P-219x**  
(M6X1, ≤ 1/16" OD Tubing)  
**P-319x**  
(M6X1, > 1/16" OD Tubing)  
**LT-115x**  
(1/4-28, ≤ 1/16" OD Tubing)

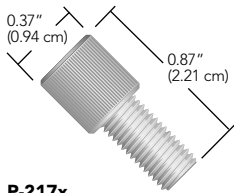

**P-217x**  
(M6X1, ≤ 1/16" OD Tubing)  
**P-317x**  
(M6X1, > 1/16" OD Tubing)  
**P-246x, P-255x, P-281x**  
(1/4-28, ≤ 1/16" OD Tubing)  
**P-331x, P-381x**  
(1/4-28, > 1/16" OD Tubing)

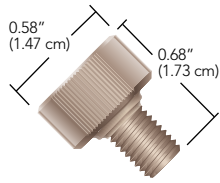

**LT-210x**  
(1/4-28, > 1/16" OD Tubing)

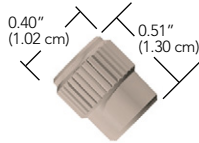

**P-420x**  
(1/4-28, ≤ 1/16" OD Tubing)  
**F-156x**  
(1/4-28, > 1/16" OD Tubing)

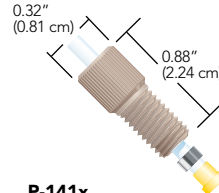

**P-141x**  
(5/16-24, ≤ 1/16" OD Tubing)  
**P-137x**  
(5/16-24, 3/16" OD Tubing)

## One-Piece Super Flangeless™ Fittings

- › All-PEEK construction
- › For 1/16" OD and 1/8" OD tubing
- › M6x1 and 1/4-28 options
- › Finger tight (2–3 in-lbs / 0.23–0.34 N·m)
- › Extremely easy to use
- › Reusable one piece design that requires no swaging

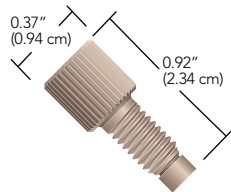

**P-329x**  
M6X1, for 1/8" OD Tubing  
**P-249x**  
1/4-28, for 1/16" OD Tubing  
**P-349x**  
1/4-28, for 1/8" OD Tubing

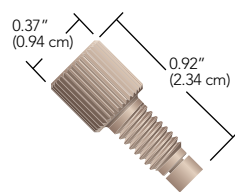

**P-229x**  
M6X1, for 1/16" OD Tubing

Super Flangeless Tubing OD / Thread Comparison

	1/32"	1/16"	1.8 MM	2.5 MM	1/8"	3/16"
<b>6-40</b>		✓				
<b>6-32</b>		✓				
<b>10-32</b>		✓				
<b>M6x1</b>	✓	✓	✓	✓	✓	
<b>1/4-28</b>	✓	✓	✓	✓	✓	
<b>5/16-24</b>						✓



## Super Flangeless™ and One-Piece Super Flangeless Fittings

Part No.	Description	Port	Pressure Rating	Head Style	Material	Qty.
<b>SUPER FLANGELESS FERRULES FOR 1/32", 1/16", 1/8", 3/16", 1.8MM, 2.0MM, 2.5MM</b>						
<b>M-250x</b>	Super Flangeless Ferrule for 1/16" OD Tubing	10-32 Flat-Bottom	1,000–5,000 psi (69–345 bar)	—	PEEK Natural/SST	10-pk
<b>M-650x</b>	Super Flangeless Ferrule for 1/16" OD Tubing	6-32 or 6-40 Flat Bottom	750–3,750 psi (52–259 bar)	—	PEEK Natural/SST	10-pk
<b>P-248x</b>	Super Flangeless Ferrule for 1/32" OD Tubing	10-32 Flat-Bottom	2,500 psi (172 bar)	—	ETFE Green/SST	10-pk
<b>P-250x</b>	Super Flangeless Ferrule for 1/16" OD Tubing	1/4-28 or M6 Flat Bottom	2,500 psi (172 bar)	—	PEEK Natural/SST	10-pk
<b>P-259x</b>	Super Flangeless Ferrule for 1/16" OD Tubing	1/4-28 or M6 Flat Bottom	1,350 psi (93 bar)	—	ETFE Yellow/SST	10-pk
<b>P-260x</b>	Super Flangeless Ferrule for 1/16" OD Tubing	1/4-28 or M6 Flat Bottom	1,850 psi (128 bar)	—	PEEK Natural/SST	10-pk
<b>P-350x</b>	Super Flangeless Ferrule for 1/8" OD Tubing	1/4-28 Flat Bottom	2,500 psi (172 bar)	—	PEEK Natural/SST	10-pk
<b>P-352x</b>	Super Flangeless Ferrule for 1/16" OD Tubing	1/4-28 or M6 Flat Bottom	2,500 psi (172 bar)	—	PEEK Black/SST	10-pk
<b>P-355x</b>	Super Flangeless Ferrule for 1.8 mm OD Tubing	1/4-28 or M6 Flat Bottom	2,500 psi (172 bar)	—	PCTFE Green/SST	10-pk
<b>P-357-2x</b>	Super Flangeless Ferrule for 2.0 mm OD Tubing	M6 Flat Bottom	5,000 psi (345 bar)	—	PEEK Natural/SST	10-pk
<b>P-359x</b>	Super Flangeless Ferrule for 1/8" OD Tubing	1/4-28 Flat Bottom	1,000 psi (69 bar)	—	ETFE Yellow/SST	10-pk
<b>P-360x</b>	Super Flangeless Ferrule for 1/8" OD Tubing	1/4-28 Flat Bottom	1,500 psi (102 bar)	—	PEEK Natural/SST	10-pk
<b>P-366x</b>	Super Flangeless Ferrule for 2.5" OD Tubing	1/4-28 Flat Bottom	1,000 psi (69 bar)	—	PEEK Natural/SST	10-pk
<b>P-140x</b>	Super Flangeless Ferrule for 3/16" OD Tubing	5/16-24 Flat Bottom	500 psi (34 bar)	—	ETFE Green/SST	10-pk
<b>6-40 AND 6-32 FITTINGS FOR 1/16" OD TUBING</b>						
<b>M-660x</b>	Super Flangeless Nut for 1/16" OD Tubing	6-32 Flat Bottom	750–3,750 psi (52–259 bar)	Micro Headless	PEEK Natural	10-pk
<b>M-644-03x</b>	Super Flangeless Nut for 1/16" OD Tubing	6-40 Flat Bottom	750–3,750 psi (52–259 bar)	Micro Headless	PEEK Green	10-pk
<b>10-32 FITTINGS FOR 1/16" OD TUBING</b>						
<b>M-652x</b>	Super Flangeless Nut for 1/16" OD Tubing	10-32 Flat Bottom	1,000–5,000 psi (69–345 bar)	1/4" Hex	PEEK Green	10-pk
<b>M-653x</b>	Super Flangeless Nut for 1/16" OD Tubing	10-32 Flat Bottom	1,000–5,000 psi (69–345 bar)	Headless Knurl	PEEK Green	10-pk
<b>M-655x</b>	Super Flangeless Nut for 1/16" OD Tubing, Long	10-32 Flat Bottom	1,000–5,000 psi (69–345 bar)	1/4" Hex	PEEK Green	10-pk
<b>M6X1 FITTINGS FOR 1/16" AND 1/32" OD TUBING</b>						
<b>P-213x</b>	Super Flangeless Nut for 1/16" or 1/32" OD Tubing, Short	M6 Flat Bottom	*	Headless Knurl	PEEK Black	10-pk
<b>P-217x</b>	Super Flangeless Nut for 1/16" or 1/32" OD Tubing	M6 Flat Bottom	*	Standard Knurl	PPS Black	10-pk
<b>P-219x</b>	Super Flangeless Nut for 1/16" or 1/32" OD Tubing, Short	M6 Flat Bottom	*	Standard Knurl	PEEK Black	10-pk
<b>M6X1 FITTINGS FOR 1.8 MM, 2.0 MM, 2.5 MM, 1/8" OD TUBING</b>						
<b>P-317x</b>	Super Flangeless For >1/16"–≤ 1/8" OD Tubing	M6 Flat Bottom	*	Standard Knurl	PPS Black	10-pk
<b>P-319x</b>	Super Flangeless Nut for 1/8" OD Tubing, Short	M6 Flat Bottom	*	Standard Knurl	PEEK Black	10-pk
<b>P-337x</b>	Super Flangeless For >1/16"–≤ 1/8" OD Tubing, Short	M6 Flat Bottom	*	Headless Knurl	PEEK Black	10-pk
<b>P-357x</b>	Super Flangeless Fitting for 2.0 mm OD Tubing	M6 Flat Bottom	*	Standard Knurl	PEEK Black, Natural/SST	10-pk
<b>1/4-28 FITTINGS FOR 1/16" AND 1/32" OD TUBING</b>						
<b>F-356x</b>	Super Flangeless Nut for 1/16" or 1/32" OD Tubing, FlushNut	1/4-28 Flat Bottom	*	FlushNut	SST	10-pk
<b>LT-105x</b>	Super Flangeless Nut for 1/16" or 1/32" OD Tubing, Short	1/4-28 Flat Bottom	*	1/4" Hex	SST	10-pk
<b>LT-115x</b>	Super Flangeless Nut for 1/16" or 1/32" OD Tubing, Short	1/4-28 Flat Bottom	*	Standard Knurl	PEEK Natural	10-pk
<b>P-232x</b>	Super Flangeless Nut for 1/16" or 1/32" OD Tubing, Short	1/4-28 Flat Bottom	*	Headless Knurl	PEEK Natural	10-pk
<b>P-246x</b>	Super Flangeless Nut for 1/16" or 1/32" OD Tubing	1/4-28 Flat Bottom	*	Standard Knurl	PFA Natural	10-pk
<b>P-255x</b>	Super Flangeless Nut for 1/16" or 1/32" OD Tubing	1/4-28 Flat Bottom	*	Standard Knurl	PEEK Natural	10-pk
<b>P-281x</b>	Super Flangeless Nut for 1/16" or 1/32" OD Tubing	1/4-28 Flat Bottom	*	Standard Knurl	PPS Natural	10-pk
<b>P-287x</b>	Super Flangeless Nut for 1/16" or 1/32" OD Tubing	1/4-28 Flat Bottom	*	Headless Knurl	PPS Natural	10-pk
<b>P-420x</b>	Super Flangeless Nut for 1/16" or 1/32" OD Tubing, Female	1/4-28 Flat Bottom	*	Female Knurl	PEEK Natural	10-pk
<b>1/4-28 FITTINGS FOR 1.8MM, 2.5 MM, 1/8" OD TUBING</b>						
<b>C-235x</b>	Super Flangeless Nut for 1/8" OD Tubing	1/4-28 Flat Bottom	*	1/4" Hex	SST	10-pk
<b>F-156x</b>	Super Flangeless Nut for 1/8" OD Tubing, Female	1/4-28 Flat Bottom	*	Female Knurl	PEEK Black	10-pk
<b>F-364x</b>	Super Flangeless Nut for 1/8" OD Tubing, FlushNut™	1/4-28 Flat Bottom	*	FlushNut	SST	10-pk
<b>LT-210x</b>	Super Flangeless Nut for 1/8" OD Tubing	1/4-28 Flat Bottom	*	Double Wings	PEEK Natural	10-pk
<b>P-331x</b>	Super Flangeless Nut for 1/8" OD Tubing	1/4-28 Flat Bottom	*	Standard Knurl	PEEK Natural	10-pk
<b>P-336x</b>	Super Flangeless Nut for 1/8" OD Tubing, Short	1/4-28 Flat Bottom	*	Headless Knurl	PEEK Natural	10-pk
<b>P-381x</b>	Super Flangeless Nut for 1/8" OD Tubing	1/4-28 Flat Bottom	*	Standard Knurl	PPS Natural	10-pk
<b>P-387x</b>	Super Flangeless Nut for 1/8" OD Tubing	1/4-28 Flat Bottom	*	Standard Knurl	PPS Natural	10-pk
<b>5/16-24 FITTINGS FOR 1/16", 1/8", 3/16" OD TUBING</b>						
<b>P-137x</b>	Super Flangeless Fitting for 3/16" OD Tubing	5/16-24 Flat Bottom	*	Standard Knurl	PEEK Black	10-pk
<b>P-141x</b>	Super Flangeless Fitting for 1/16" OD Tubing	5/16-24 Flat Bottom	*	Standard Knurl	PEEK Natural	10-pk
<b>ONE-PIECE SUPER FLANGELESS FITTINGS FOR 1/16" AND 1/8" OD TUBING</b>						
<b>P-229x</b>	One Piece Super Flangeless Fitting for 1/16" OD Tubing	M6 Flat Bottom	1,000 psi (69 bar)	Standard Knurl	PEEK	10-pk
<b>P-249x</b>	One Piece Super Flangeless Fitting for 1/16" OD Tubing	1/4-28 Flat Bottom	1,000 psi (69 bar)	Standard Knurl	PEEK	10-pk
<b>P-329x</b>	One Piece Super Flangeless Fitting for 1/16" OD Tubing	M6 Flat Bottom	1,000 psi (69 bar)	Standard Knurl	PEEK	10-pk
<b>P-349x</b>	One Piece Super Flangeless Fitting for 1/16" OD Tubing	1/4-28 Flat Bottom	1,000 psi (69 bar)	Standard Knurl	PEEK	10-pk

\* Pressure rating of nut depends on the ferrule used.



# VacuTight™ Fittings

- › For 1/16" or 1/8" OD tubing connections into 10-32, 1/4-28, or M6 flat-bottom ports
- › Vacuum Rated to 25 in-Hg (84 kPa)
- › Improve transfer volume consistency

VacuTight Fittings are designed to provide airtight, dependable connections under vacuum and low pressure conditions. Many of the VacuTight Nuts have streamlined profiles for use in systems requiring a large number of connections in a small area. Furthermore, the VacuTight Ferrule's small size ensures sufficient nut/thread engagement, even in shallow ports. These features make VacuTight Fittings ideal for "combi chem" high throughput screening, clinical diagnostic, and other automated liquid handling applications.

The configuration of the VacuTight flat-bottom ferrules prevents overcompression and tubing ID reduction that can occur with many coned fittings. The result is more consistent aspirating and dispensing volumes across all system connections.

The VacuTight fittings can also work well in some positive pressure applications. The pressure range for each fitting is listed below and depends upon the tubing used for the connection. Please contact your distributor or IDEX Health & Science for more information. Additionally, please note that some of the VacuTight fittings have changed in color from red to black; however, this color change does not affect product performance.

All VacuTight Nuts must be used exclusively with VacuTight Ferrules.

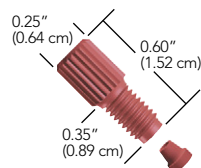

**P-844x**  
PEEK Nut, 10-32  
with P-840 Ferrule



**P-846x**  
PEEK Nut, 10-32  
with P-840 Ferrule

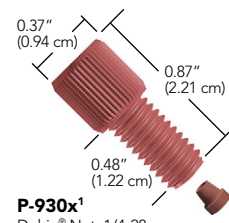

**P-930x¹**  
Delrin® Nut, 1/4-28  
with P-840 Ferrule

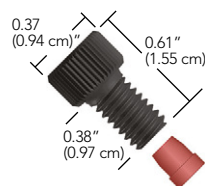

**P-945x²**  
Delrin Nut, M6  
with P-940 Ferrule

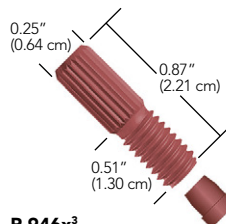

**P-946x³**  
Delrin Nut, 1/4-28  
with P-940 Ferrule

<sup>1</sup> The dimensions shown apply to P-930x, P-931x, P-938x, P-942x, and P-948x.

<sup>2</sup> The dimensions shown apply to P-945x.

<sup>3</sup> The dimensions shown apply to P-946x.

Part No.	Description	Port	Pressure Rating	Head Style	Material	Qty.
<b>VACUTIGHT FITTINGS (INCLUDES P-840 OR P-940 FERRULES)</b>						
<b>P-842x</b>	VacuTight Fitting for 1/16" OD Tubing, Short	10-32 Flat-Bottom	400–800 psi (27–55 bar)	1/4" Hex	PEEK Red	10-pk
<b>P-844x</b>	VacuTight Fitting for 1/16" OD Tubing, Short	10-32 Flat-Bottom	400–800 psi (27–55 bar)	Headless Knurl	PEEK Red	10-pk
<b>P-846x</b>	VacuTight Fitting for 1/16" OD Tubing, Long	10-32 Flat-Bottom	400–800 psi (27–55 bar)	Headless Knurl	PEEK Red	10-pk
<b>P-930x</b>	VacuTight Fitting for 1/16" OD Tubing	1/4-28 Flat-Bottom	400–800 psi (27–55 bar)	Standard Knurl	Delrin Red	10-pk
<b>P-931x</b>	VacuTight Fitting for 1/16" OD Tubing	M6 Flat-Bottom	400–800 psi (27–55 bar)	Standard Knurl	Delrin Red	10-pk
<b>P-938x</b>	VacuTight Fitting for 1/16" OD Tubing	1/4-28 Flat-Bottom	400–800 psi (27–55 bar)	Standard Knurl	PEEK Natural	10-pk
<b>P-942x</b>	VacuTight Fitting for 1/8" OD Tubing	1/4-28 Flat-Bottom	500–1,000 psi (34–69 bar)	Standard Knurl	Delrin Red	10-pk
<b>P-945x</b>	VacuTight Fitting for 1/8" OD Tubing, Short	M6 Flat-Bottom	500–1,000 psi (34–69 bar)	Standard Knurl	Delrin Black	10-pk
<b>P-946x</b>	VacuTight Fitting for 1/8" OD Tubing	1/4-28 Flat-Bottom	500–1,000 psi (34–69 bar)	Headless Knurl	Delrin Red	10-pk
<b>P-948x</b>	VacuTight Fitting for 1/8" OD Tubing	1/4-28 Flat-Bottom	500–1,000 psi (34–69 bar)	Standard Knurl	PEEK Natural	10-pk
<b>REPLACEMENT FERRULES</b>						
<b>P-840</b>	VacuTight Ferrule for 1/16" OD Tubing	M6 or 1/4-28 Flat-Bottom	400–800 psi (27–55 bar)	—	ETFE Red	ea.
<b>P-940x</b>	VacuTight Ferrule for 1/8" OD Tubing	M6 or 1/4-28 Flat-Bottom	500–1,000 psi (34–69 bar)	—	ETFE Red	10-pk

# Metric Flangeless Fittings

- › For 1/16", 1.8 mm, 2.0 mm, 2.5 mm, 3.0 mm, 4.0 mm, or 1/8" OD tubing
- › Convenience of flangeless fittings for metric tubing sizes and M6 flat-bottom ports

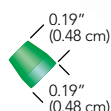

**P-342x**  
ETFE Ferrule  
for 1.8 OD tubing

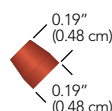

**P-363Rx**  
ETFE Ferrule  
for 2.0 mm OD tubing

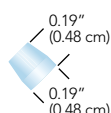

**P-353x**  
ETFE Ferrule  
for 2.5 mm OD tubing

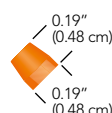

**P-343x**  
ETFE Ferrule  
for 3.0 mm OD tubing

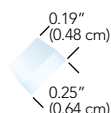

**P-344x**  
ETFE Ferrule  
for 4.0 mm OD tubing

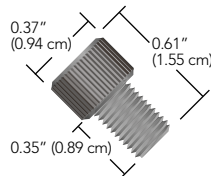

**P-347x**  
PEEK Nut  
for 1.8, 2.0, 3.0 mm or  
1/8" OD tubing

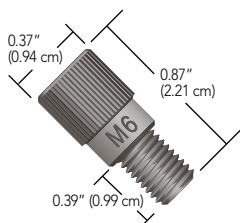

**P-207x**  
Delrin® Nut  
for 1/16" OD tubing

Metric Flangeless Ferrules are designed to connect 1.8, 2.0, 2.5, 3.0, or 4.0 mm OD tubing to flat-bottom ports when paired with the appropriate M6, 1/4-28, or 5/16-24 Flangeless Nuts. We also offer M6-threaded nuts to connect 1/16" or 1/8" OD tubing, plus a tubing sleeve to facilitate 1.0 mm OD tubing connections. Please refer to the "Metric Connections" chart on this page for information regarding which nuts and ferrules to use with your tubing.

## METRIC CONNECTIONS

Use this chart to determine the low pressure fittings needed to connect metric and English-sized tubing into the indicated ports.

Tubing Size	Port	Ferrules	Nuts
<b>1.0 mm</b>	M6 1/4-28	P-200x (w/F-252 sleeve, not included) P-200x (w/F-252 sleeve, not included)	P-207x, P-207Sx, P-247x Any 1/4-28 nut for 1/16" OD tubing from page 47
<b>1.8 mm</b>	M6 1/4-28	P-342x P-342x	P-307x, P-307Sx, P-347x Any 1/4-28 nut for 1/8" OD tubing from page 47
<b>2.0 mm</b>	M6 1/4-28	P-363Rx P-363Rx	P-307x, P-307Sx, P-347x Any 1/4-28 nut for 1/8" OD tubing from page 47
<b>2.5 mm</b>	M6 1/4-28	P-353x P-353x	P-307x, P-307Sx, P-347x Any 1/4-28 nut for 1/8" OD tubing from page 47
<b>3.0 mm</b>	M6 1/4-28	P-343x P-343x	P-307x, P-307Sx, P-347x Any 1/4-28 nut for 1/8" OD tubing from page 47
<b>4.0 mm</b>	5/16-24	P-344x	XP-132x from page 56
<b>1/16"</b>	M6 M6	P-200x P-840	P-207x, P-207Sx, P-247x, P-931, page 42
<b>1/8"</b>	M6 M6	P-300x P-940x	P-307x, P-307Sx, P-347x, P-945x, page 42

## RELATED PRODUCTS

MORE METRIC-SIZED PRODUCTS	Page	Page
<b>High Pressure Polymer Fittings</b>	58	<b>Low Pressure Unions</b> 84
<b>High Pressure Stainless Steel Fittings</b>	59	<b>Bulkhead Unions</b> 82
<b>Luer Adapters</b>	87	<b>PEEK (1.8 mm OD and Capillary) and Fused Silica Tubing</b> 16
<b>Metric Threaded Adapters</b>	65	<b>PEEKsil™ Tubing</b> 22
<b>External NPT Adapters</b>	66	<b>FEP Tubing (1.0–4.0 mm OD) and PFA Capillary Tubing</b> 26
<b>VacuTight™ Fittings</b>	42	<b>Frit-In-A-Ferrule™</b> 99
<b>Plugs and Caps</b>	55	

In addition, many of our 1/4-28 threaded Filters, Valves and Flow Control Accessories can be converted to accept 1.8, 2.0, 2.5 and 3.0 mm tubing, using the ferrules listed for 1/4-28 ports in the "Metric Connections" table, this page.

Part No.	Description	Port	Pressure Rating	Head Style	Material	Qty.
<b>METRIC FLANGELESS NUTS</b>						
<b>P-207x</b>	Flangeless Nut for 1/16" OD Tubing	M6 Flat-Bottom	2,000 psi (138 bar)	Standard Knurl	Delrin Black	10-pk
<b>P-2075x</b>	Flangeless Nut for 1/16" OD Tubing, Short	M6 Flat-Bottom	2,000 psi (138 bar)	Standard Knurl	Delrin Black	10-pk
<b>P-247x</b>	Flangeless Nut for 1/16" OD Tubing, Short	M6 Flat-Bottom	2,000 psi (138 bar)	Standard Knurl	PEEK Black	10-pk
<b>P-307x</b>	Flangeless Nut for 1.8 mm, 2.0 mm, 3.0 mm, 1/8" OD Tubing	M6 Flat-Bottom	500 psi (34 bar)	Standard Knurl	Delrin Black	10-pk
<b>P-3075x</b>	Flangeless Nut for 1.8 mm, 2.0 mm, 3.0 mm, 1/8" OD Tubing	M6 Flat-Bottom	500 psi (34 bar)	Standard Knurl	Delrin Black	10-pk
<b>P-347x</b>	Flangeless Nut for 1.8 mm, 2.0 mm, 3.0 mm, 1/8" OD Tubing	M6 Flat-Bottom	500 psi (34 bar)	Standard Knurl	PEEK Black	10-pk
<b>FLANGELESS FERRULES</b>						
<b>F-252x</b>	1/16" OD Tubing Sleeve for 1.0 mm ID Tubing	M6 or 1/4-28 Flat-Bottom	500 psi (34 bar)	—	FEP Purple	10-pk
<b>P-200x</b>	Flangeless Ferrule for 1/16" OD Tubing	M6 or 1/4-28 Flat-Bottom	2,000 psi (138 bar)	—	ETFE Blue	10-pk
<b>P-300x</b>	Flangeless Ferrule for 1/8" OD Tubing	M6 or 1/4-28 Flat-Bottom	500 psi (34 bar)	—	ETFE Yellow	10-pk
<b>P-342x</b>	Flangeless Ferrule for 1.8 mm OD Tubing	M6 or 1/4-28 Flat-Bottom	500 psi (34 bar)	—	ETFE Green	10-pk
<b>P-343x</b>	Flangeless Ferrule for 3.0 mm OD Tubing	M6 or 1/4-28 Flat-Bottom	500 psi (34 bar)	—	ETFE Orange	10-pk
<b>P-344x</b>	Flangeless Ferrule for 4.0 mm OD Tubing	5/16-24	250 psi (17 bar)	—	ETFE Natural	10-pk
<b>P-353x</b>	Flangeless Ferrule for 2.5 mm OD Tubing	M6 or 1/4-28 Flat-Bottom	500 psi (34 bar)	—	ETFE Natural	10-pk
<b>P-363Rx</b>	Flangeless Ferrule for 2.0 mm OD Tubing	M6 or 1/4-28 Flat-Bottom	500 psi (34 bar)	—	ETFE Red	10-pk



# Flanged Fittings

- › Fittings for 1/16" or 1/8" OD tubing, supplied with nut and 316 stainless steel washer
- › Multiple head styles and materials available; contact IDEX Health & Science for more information
- › For 1/4-28 and M6 flat-bottom ports
- › Some color options available; call for more information

Flanged Fittings are compatible with most standard 1/4-28 or M6 Flat-Bottom flanged fittings. The Delrin® (acetal resin) nut resists cross threading or loosening during use.

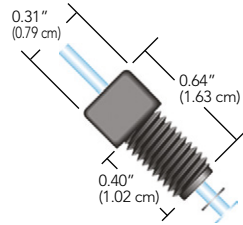

**P-401x<sup>1</sup>**  
Flanged Fitting for 1/16" OD tubing\*

<sup>1</sup> The dimensions shown apply to all square-head Flanged Fittings

\* Flanged tubing not included

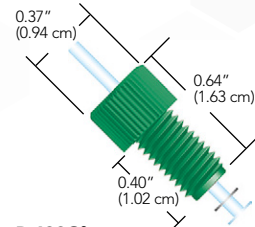

**P-482G<sup>3</sup>**  
Flanged Fitting for 1/16" OD tubing\*

<sup>3</sup> The dimensions shown apply to all knurled-head Flanged Fittings

\* Flanged tubing not included



## RELATED PRODUCTS

- › For an alternative to flanging tubing, we highly recommend the Flangeless Fittings found on page 45, the Super Flangeless™ Fittings found on page 39, or the VacuTight™ Fittings on page 42.

Part No.	Description	Port Geometry	Head Style	Material (Nut/Washer)	Qty.
<b>FLANGED FITTINGS (INCLUDES STAINLESS STEEL WASHERS)</b>					
<b>P-401x</b>	Flanged Fitting for 1/16" OD Tubing	1/4-28 Flat-Bottom	5/16" Square	Delrin Black/SST	10-pk
<b>P-482BLK</b>	Flanged Fitting for 1/16" OD Tubing	1/4-28 Flat-Bottom	Standard Knurl	Delrin Black/SST	ea.
<b>P-501x</b>	Flanged Fitting for 1/8" OD Tubing	1/4-28 Flat-Bottom	5/16" Square	Delrin Black/SST	10-pk
<b>P-982BLKx</b>	Flanged Fitting for 1/16" OD Tubing	M6 Flat-Bottom	Standard Knurl	Delrin Black/SST	10-pk
<b>P-1082BLKx</b>	Flanged Fitting for 1/8" OD Tubing	M6 Flat-Bottom	Standard Knurl	Delrin Black/SST	10-pk
<b>REPLACEMENT WASHERS</b>					
<b>P-407x</b>	Washer for 1/16" OD Tubing	1/4-28 Flat-Bottom	—	SST	10-pk
<b>P-507x</b>	Washer for 1/8" OD Tubing	1/4-28 Flat-Bottom	—	SST	10-pk
<b>P-1087x</b>	Washer for 1/8" OD Tubing	M6 Flat-Bottom	—	SST	10-pk



# Flangeless Fittings



## THE CONVENIENCE OF FLANGELESS FITTINGS



Our Flangeless Nuts provide fingertight convenience — no wrenches required.

Our Flangeless Ferrules provide a leak-proof seal. There is no need to spend time flanging tubing.

Flangeless Fittings eliminate the need to flange tubing. This removable and reusable system provides several benefits:

**Convenience:** Flangeless Fittings are easy to use. Just slip the nut and ferrule over the tubing and finger tighten the assembly into your receiving port. In tests, it is shown that the ideal amount of torque to achieve expected part performance should be approximately 3–4 in-lbs (0.34–0.45 N·m). Check out the line of special tightening tools designed to adapt to many standard torque wrenches, on page 50 and the adjustable torque driver, VHP-4000 on page 51.

**Minimal Down-Time:** Component replacement is quick, taking only a few seconds — unlike the significant time required to flange tubing.

**Cost-Effectiveness:** Repairing a flanged tubing assembly requires a costly flanging tool or the purchase of a complete replacement assembly, including a new length of tubing and a set of fittings. The Flangeless Fittings system typically requires only one new ferrule at minimal cost when repairing a connection.

The 1/4-28 and M6 Flangeless Fittings for 1/16", 1/8", and metric sized OD tubing are summarized on the following page and listed on page 47.

## 1/4-28 Flangeless Fittings – Nuts

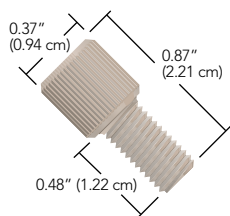

### Standard

XP-201x  
XP-202x  
XP-220x  
XP-230x  
XP-238x  
XP-245x  
XP-301x – XP-305x  
XP-330x

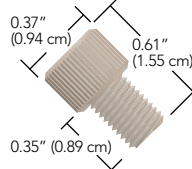

### Short

XP-218x  
XP-235x  
XP-308x  
XP-335x  
P-207Sx  
P-247x  
P-307Sx  
P-347x

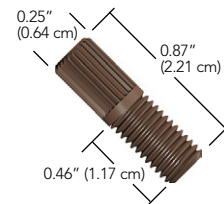

### Headless

XP-286x

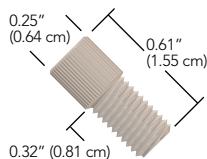

### Short Headless

XP-283x

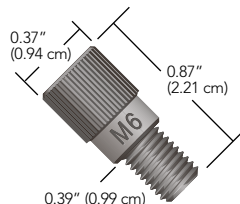

### Standard Metric

P-207x  
P-307x

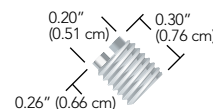

### FlushNut™

XF-358x  
XF-368x

## Flangeless Fittings (Cont.)

### NOTE

- › The XP-340x ferrule is designed for use with shallow receiving ports, such as those used on some low pressure valves.



**XP-340x**  
ETFE Small Valve Ferrule

- › The XF-368x FlushNut is an excellent choice for applications where port-to-port spacing is limited; see page 31 for more information on this innovative product line. As an alternative, consider one of the "headless" fittings shown on this page.

### Ferrules

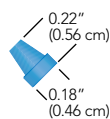

**Standard 1/16"**  
P-200x  
XP-200Nx

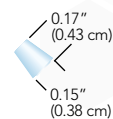

**Small Valve 1/16"**  
XP-240x

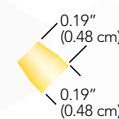

**Standard 1/8"  
and Metric Ferrules**  
XP-300x  
XP-300Nx  
P-342x  
P-353x  
P-363Rx  
P-343x

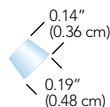

**Small Valve 1/8"**  
XP-340x

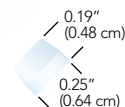

**Standard 4.0 mm**  
P-344x

### RELATED PRODUCTS

- › For the Large Bore Flangeless Fittings, please refer to page 56.
- › Nuts for M6 threaded ports are on page 43; nuts for 5/16-24 threaded ports are on page 56.

### Flangeless Fittings for 1/16" and 1/8" OD Tubing

- › Wide variety of materials and geometries to fit most applications
- › Excellent replacement for flanged fittings
- › Convenient and easy to use
- › Fittings and ferrules packaged together for easy ordering convenience

Flangeless Fittings for 1/16" OD Tubing, and for 1/8" OD Tubing are available in a variety of materials. The replacement ferrules are manufactured from inert ETFE, and are sold in a colored version or ETFE's natural color as the N option. The smaller ferrules, XP-240x and XP-340x are designed for shallow ports.

The fittings shown on this page are packaged together with the ferrules in convenient 10-packs. The 1/16" version include the XP-200x ferrule, and the 1/8" version include the XP-300x ferrule. Please visit our website, [www.idex-hs.com](http://www.idex-hs.com), for single packaging options.

For higher pressure and temperature applications consider our Super Flangeless™ found on page 39.

### Lock Nut

The XP-312x Lock Nut is for use with any 1/4-28 male Flangeless Fitting. Use this product in applications where vibrations can loosen fittings.

**To Use:** Thread the lock nut onto the male fitting. When the male fitting is firmly seated into the receiving port, tighten the lock nut down against the receiving port to securely hold the male fitting in place.



**XP-312x**  
Lock Nut White Delrin

## Flangeless Fittings

Part No.	Description	Port	Pressure Rating	Head Style	Material	Qty.
<b>FLANGELESS FITTINGS FOR 1/16" OD TUBING</b>						
<b>XF-358x</b>	Flangeless Fitting for 1/16" OD Tubing, FlushNut	1/4-28 Flat-Bottom	2,000 psi (138 bar)	FlushNut	SST	10-pk
<b>XLT-111x</b>	Flangeless Fitting for 1/16" OD Tubing	10-32 Flat-Bottom	2,500 psi (172 bar)	Standard Knurl	PEEK Natural	10-pk
<b>XP-201x</b>	Flangeless Fitting for 1/16" OD Tubing	1/4-28 Flat-Bottom	2,000 psi (138 bar)	Standard Knurl	Delrin Black	10-pk
<b>XP-202x</b>	Flangeless Fitting for 1/16" OD Tubing	1/4-28 Flat-Bottom	2,000 psi (138 bar)	Standard Knurl	Delrin Red	10-pk
<b>XP-218x</b>	Flangeless Fitting for 1/16" OD Tubing	1/4-28 Flat-Bottom	2,000 psi (138 bar)	Standard Knurl	ETFE Natural	10-pk
<b>XP-230x</b>	Flangeless Fitting for 1/16" OD Tubing	1/4-28 Flat-Bottom	2,000 psi (138 bar)	Standard Knurl	PEEK Natural	10-pk
<b>XP-235x</b>	Flangeless Fitting for 1/16" OD Tubing, Short	1/4-28 Flat-Bottom	2,000 psi (138 bar)	Standard Knurl	PEEK Natural	10-pk
<b>XP-238x</b>	Flangeless Fitting for 1/16" OD Tubing	1/4-28 Flat-Bottom	2,000 psi (138 bar)	Standard Knurl	Delrin Purple	10-pk
<b>XP-245x</b>	Flangeless Fitting for 1/16" OD Tubing	1/4-28 Flat-Bottom	2,000 psi (138 bar)	Standard Knurl	PFA Natural	10-pk
<b>XP-286x</b>	Flangeless Fitting for 1/16" OD Tubing	1/4-28 Flat-Bottom	2,000 psi (138 bar)	Headless Knurl	PPS Natural	10-pk
<b>REPLACEMENT FERRULES FOR 1/16" OD TUBING</b>						
<b>XP-200x</b>	Flangeless Ferrule for 1/16" OD Tubing	1/4-28 Flat-Bottom	2,000 psi (138 bar)	—	ETFE Blue	10-pk
<b>XP-200Nx</b>	Flangeless Ferrule for 1/16" OD Tubing	1/4-28 Flat-Bottom	2,000 psi (138 bar)	—	ETFE Natural	10-pk
<b>XP-240x</b>	Flangeless Ferrule for 1/16" OD Tubing, Small Valve	1/4-28 or 10-32 Flat-Bottom	2,500 psi (172 bar)	—	ETFE Natural	10-pk
<b>FLANGELESS FITTINGS FOR 1/8" OD TUBING (INCLUDES P-300 FERRULES)</b>						
<b>XF-368x</b>	Flangeless Fitting for 1/8" OD Tubing, FlushNut	1/4-28 Flat-Bottom	500 psi (34 bar)	FlushNut	SST	10-pk
<b>XP-301x</b>	Flangeless Fitting for 1/8" OD Tubing	1/4-28 Flat-Bottom	500 psi (34 bar)	Standard Knurl	Delrin Black	10-pk
<b>XP-302x</b>	Flangeless Fitting for 1/8" OD Tubing	1/4-28 Flat-Bottom	500 psi (34 bar)	Standard Knurl	Delrin Red	10-pk
<b>XP-305x</b>	Flangeless Fitting for 1/8" OD Tubing	1/4-28 Flat-Bottom	500 psi (34 bar)	Standard Knurl	Delrin Green	10-pk
<b>XP-308x</b>	Flangeless Fitting for 1/8" OD Tubing, Short	1/4-28 Flat-Bottom	500 psi (34 bar)	Standard Knurl	Delrin Black	10-pk
<b>XP-315x</b>	Flangeless Fitting for 1/8" OD Tubing	1/4-28 Flat-Bottom	500 psi (34 bar)	Standard Knurl	ETFE Natural	10-pk
<b>XP-330x</b>	Flangeless Fitting for 1/8" OD Tubing	1/4-28 Flat-Bottom	500 psi (34 bar)	Standard Knurl	PEEK Natural	10-pk
<b>XP-335x</b>	Flangeless Fitting for 1/8" OD Tubing, Short	1/4-28 Flat-Bottom	500 psi (34 bar)	Standard Knurl	PEEK Natural	10-pk
<b>REPLACEMENT FERRULES FOR 1/8" OD TUBING</b>						
<b>XP-300x</b>	Flangeless Ferrule for 1/8" OD Tubing	1/4-28 Flat-Bottom	500 psi (34 bar)	—	ETFE Yellow	10-pk
<b>XP-300Nx</b>	Flangeless Ferrule for 1/8" OD Tubing	1/4-28 Flat-Bottom	500 psi (34 bar)	—	ETFE Natural	10-pk
<b>XP-340x</b>	Flangeless Ferrule for 1/8" OD Tubing, Small Valve	1/4-28 Flat-Bottom	500 psi (34 bar)	—	ETFE Natural	10-pk
<b>XP-312x</b>	Lock Nut for Flangeless Nuts	1/4-28 Flat-Bottom	—	—	Delrin White	10-pk





Bio

- › Finger-tight to 19,000 psi
- › Reusable up to 200 times
- › Zero Dead Volume
- › Biocompatible
- › Limit Wear
- › Increase Product Life
- › Many IDs and Lengths Available



## LEARN MORE

Learn more about MarvelX Next Generation UHPLC Fittings at [www.idex-hs.com/MarvelX](http://www.idex-hs.com/MarvelX)



## NOTE

- › MarvelX tubing includes a sleeve that assists in product identification, with ID, length and part number information:

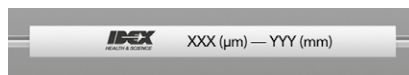

- › Minimum recommended bend-radius with MarvelX tubing is 1/4" (~6.35 mm).

## MarvelX™

## MarvelX™ Next Generation UHPLC Fittings

MarvelX UHPLC Connection Systems have been expertly designed for easy routing throughout your instrument, while providing consistent performance and superior re-usability. Built with convenient, removable stainless steel fittings and changeable, precision-cut flexible tubing, MarvelX can be used up to 200 times! The connection system is compatible with 10-32 coned receiving ports and is absolutely finger-tight — no tool required. MarvelX utilizes our unique next-generation patent-pending technology to auto-adjust to various port depths. This ensures zero dead volume and delivers better chromatography results with sleek, simple, and reliable functionality. In addition to our powerful Stainless Steel version, MarvelX offers a truly biocompatible option in PEEK-Lined Stainless Steel.

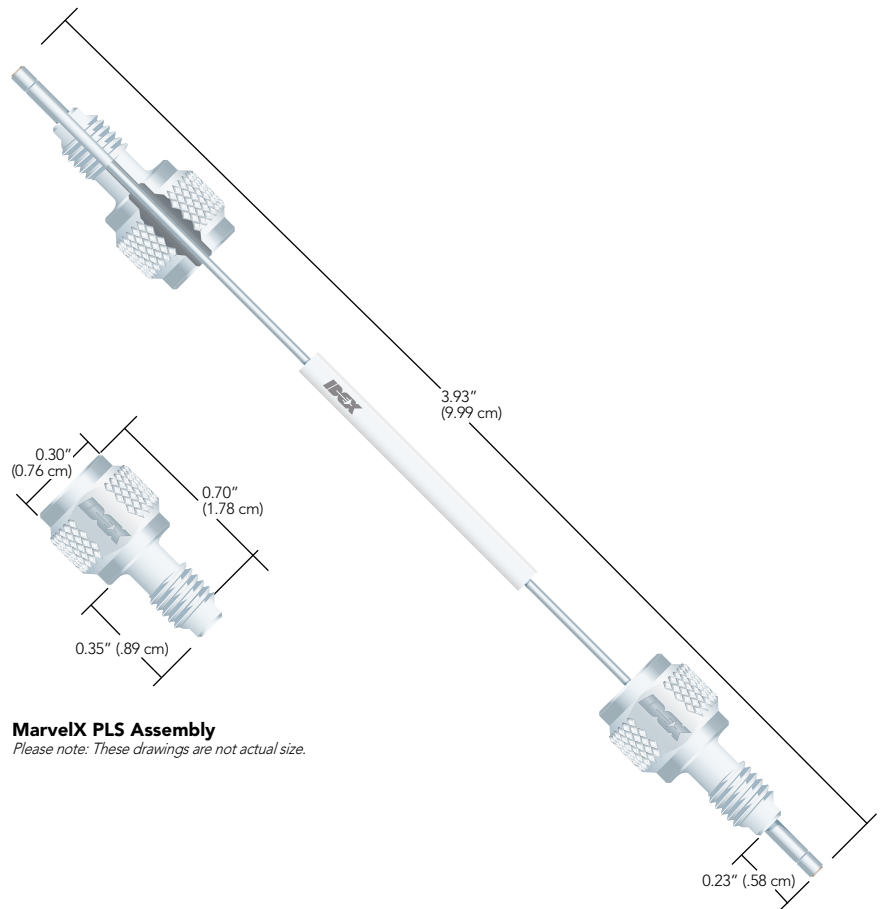

## MarvelX PLS Assembly

Please note: These drawings are not actual size.



## SPECIFICATIONS &amp; DETAILS

<b>Pressure Capability</b>	19,000 psi (~1,310 bar) for routine use; up to 23,000 psi max over pressure for PEEK-Lined versions; up to 29,000 psi max over pressure for Stainless Steel versions.
<b>Installation Method</b>	Finger-tight, 1/8 – 1/4 turn after initial resistance (~2 in-lbs)
<b>Tubing Type</b>	1/32" OD flexible 316 Stainless Steel with 1/16" OD rigid tube ends
<b>Fitting Type</b>	10-32 threaded, removable 316 Stainless Steel
<b>Wetted Materials</b>	PEEK-Lined versions: PEEK   Stainless Steel versions: PEEK and 316 Stainless Steel
<b>Maximum Use Temperature</b>	120 °C

NOTE: The above performance specifications apply to use with appropriately-designed receiving ports under optimal conditions, using water at up to 120 °C for the testing process. If different conditions are used, the expected pressure threshold will be different.



## INSTRUCTIONS FOR TIGHTENING

- 1 Route tubing to the target port.
- 2 Slide fitting onto the tubing end via slot.
- 3 Slowly finger-tighten to first resistance; continue tightening 1/8-turn minimum, to 1/4-turn maximum.

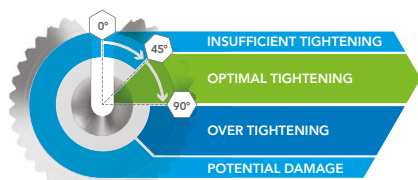

## MARVELX™ UHPLC FITTINGS VS. CONVENTIONAL CONED FITTINGS

**Conventional coned fittings** require a ferrule in conjunction with a fitting for proper sealing. They depend on complex techniques, including tools, to improve sealing performance, which significantly increases probability of extra internal volume and poor chromatography results. The excessive force needed for tightening increases wear of expensive components and the likelihood of replacement, adding to overall costs.

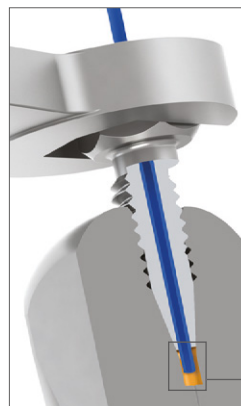

**MarvelX UHPLC fittings** do not depend on ferrules. They seal at the bottom of the port, without complex techniques, which significantly reduces required torque and enables many more connects and disconnects. Furthermore, they are virtually impossible to over-tighten by hand, limiting wear and increasing product life. An enhanced proprietary tip design also ensures zero dead volume (ZDV) and better chromatography results.

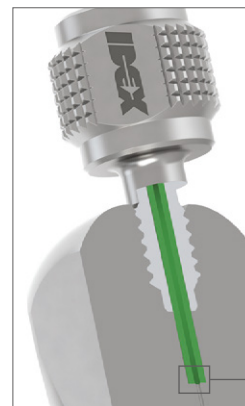

## MarvelX

Length	070 MM Part No.	150 MM Part No.	250 MM Part No.	350 MM Part No.	500 MM Part No.	600 MM Part No.
<b>PEEK-LINED STAINLESS STEEL ASSEMBLIES*</b>						
25 µm ID	UPFP-6025070	UPFP-6025150	UPFP-6025250	UPFP-6025350	UPFP-6025500	UPFP-6025600
50 µm ID	UPFP-6050070	UPFP-6050150	UPFP-6050250	UPFP-6050350	UPFP-6050500	UPFP-6050600
75 µm ID	UPFP-6075070	UPFP-6075150	UPFP-6075250	UPFP-6075350	UPFP-6075500	UPFP-6075600
100 µm ID	UPFP-6100070	UPFP-6100150	UPFP-6100250	UPFP-6100350	UPFP-6100500	UPFP-6100600
150 µm ID	UPFP-6150070	UPFP-6150150	UPFP-6150250	UPFP-6150350	UPFP-6150500	UPFP-6150600
300 µm ID	UPFP-6300070	UPFP-6300150	UPFP-6300250	UPFP-6300350	UPFP-6300500	UPFP-6300600
<b>STAINLESS STEEL ASSEMBLIES*</b>						
100 µm ID	UPFS-6100070	UPFS-6100150	UPFS-6100250	UPFS-6100350	UPFS-6100500	UPFS-6100600
125 µm ID	UPFS-6125070	UPFS-6125150	UPFS-6125250	UPFS-6125350	UPFS-6125500	UPFS-6125600
254 µm ID	UPFS-6254070	UPFS-6254150	UPFS-6254250	UPFS-6254350	UPFS-6254500	UPFS-6254600
<b>REPLACEMENT PARTS*</b>						

Replacement Tubing To order Replacement Tubing, simply add the letter "T" to the end of any of the part numbers listed above. Example: UPFP-6020570T is the replacement tubing for UPFP-6020570.

Replacement Fittings UPN-61032 – Includes 3 replacement fittings.

\*Product availability and lead times may vary depending on the configuration. Contact Customer Service at +1 800 426 0191 or email CustomerService.hs@idexcorp.com for details.

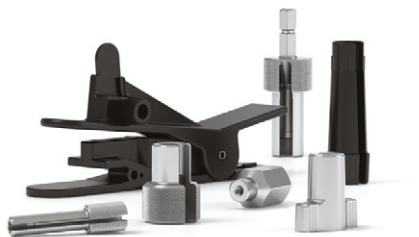

# Fittings Tools

## Tightening Tools for VHP & Other Fittings

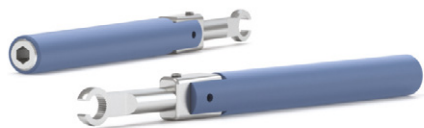

**VHP-1000**  
VHP Wrench  
1/4 in Hex 10 in-lbs (1.13 N·m)

- › Configured for the optimum torque to provide assurance of a strong connection
- › Prolongs the lifetime of reusable fittings by not overtightening
- › Available for multiple fitting head styles

This new line of tightening tools is designed for the VHP fittings and can also be used with any fitting in this chapter described to have a corresponding head style to the tool listed below. There are three styles of tightening tools available for various applications. The Torque Tools (VHP-1000 and VHP-2000) are breakaway torque wrenches designed to deliver a precise amount of torque to the fitting system. These torque wrenches come calibrated according to ISO 6789:2003 ( $\pm 6\%$  of setting) and have been tested extensively with the reusable VHP fittings on page 60. Choose the appropriate torque delivered and the proper head style to work with the VHP fittings, increasing the ease of use with these fittings.

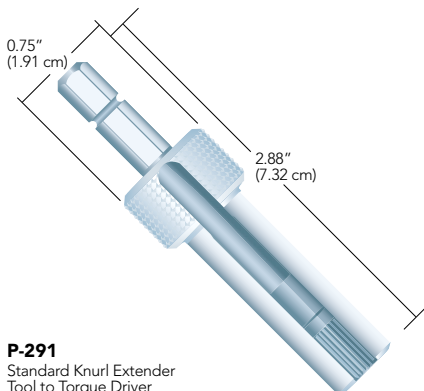

**P-291**  
Standard Knurl Extender  
Tool to Torque Driver

The VHP-4000 Torque Driver couples with the specially designed Extender Tools listed below and provides an externally adjustable torque setting. This tool along with the appropriate Extender Tools will tighten any IDEX Health & Science knurled polymer fitting in your system. Reference the head style found in the tables at the bottom of each page for information on the proper Extender Tool to select.

Because of the small hex-head on the M4 fittings (VHP-900 and VHP-920), a custom wrench, the VHP-9000, is available in the table at the bottom of the page 51.

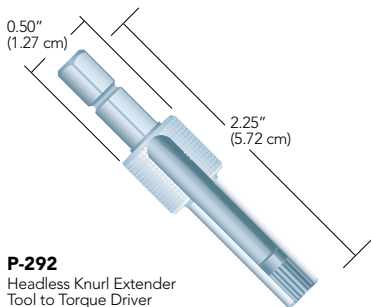

**P-292**  
Headless Knurl Extender  
Tool to Torque Driver

## Extender Tools

These tools can be used to tighten most of our knurled nuts in hard to reach places. See the application note on this page for knurl size and corresponding extender tool.

For precise tightening, the extender tools listed with 1/4" hex drives are designed to adapt to any torque wrench with a female 1/4" socket, such as the VHP-4000 Torque Driver on page 51. The tools featured on this page also include the FlushNut™ wrenches, used to tighten the FlushNuts found throughout this chapter and described in detail on page 51.

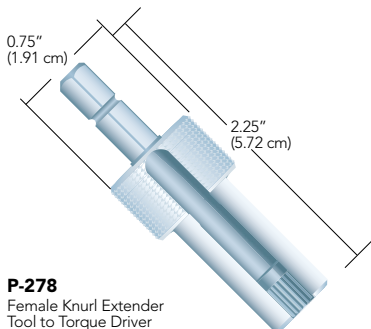

**P-278**  
Female Knurl Extender  
Tool to Torque Driver

## APPLICATION NOTE

The drawings represent actual size of the various knurled head designs of the IDEX Health & Science nuts featured in this chapter. Select the appropriate extender tool for the knurl pattern of the nut you've selected.

FEMALE KNURL	STANDARD KNURL	HEADLESS KNURL
STANDARD MICRO KNURL	MICRO HEADLESS KNURL	



## Removal Tool

Use the LT-300 Removal Tool to detach LiteTouch® and Super Flangeless™ Ferrules from tubing. Simply slide the appropriate tool blade slot between the lock ring and the ferrule body. With a slight twist, the ring will pop off, releasing the ferrule from the tubing. *Please Note: This Removal Tool will not work with the LT-135x Ferrule System.*



## Wrenches

For your convenience, we offer wrenches in three standard sizes. You will need two A-304 wrenches to tighten most nuts into unions found on page 36 (for union 1593, you need one A-304 and one A-320 wrench).

The IDEX Wrench is slotted to fit over 1/16" and 1/8" OD tubing, and has 1/4" and 5/16" internal hex ends, to engage with the heads of the hex-head fittings most commonly used with IDEX Health & Science valves and the stainless steel fittings listed on page 59.

## Fittings Tools

Part No.	Description	Use With Head Style	Torque Delivered	Qty.
<b>VHP TIGHTENING TOOLS</b>				
F-347	Extender Tool to Torque Driver	FlushNut (1/4-28)	—	ea.
N-291	Extender Tool to Torque Driver	Micro Headless	—	ea.
P-268	Extender Tool to Torque Driver	1/4" Hex	—	ea.
P-278	Extender Tool to Torque Driver	Female Nut Knurl	—	ea.
P-279	Extender Tool to Torque Driver	Micro Nut Knurl	—	ea.
P-291	Extender Tool to Torque Driver	Standard Nut Knurl	—	ea.
P-292	Extender Tool to Torque Driver	Headless Nut Knurl	—	ea.
P-1000	Standard Knurl Torque Tool	Standard Knurl	4 in-lbs (0.45 N-m)	ea.
VHP-1000	VHP Torque Tool	1/4" Hex	10 in-lbs (1.13 N-m)	ea.
VHP-2000	VHP Torque Tool	1/4" Hex	14 in-lbs (1.58 N-m)	ea.
VHP-4000	VHP Torque Driver	Extender Tool 1/4" Drive	Adjustable between 2–12 in-lbs (0.23–1.35 N-m)	ea.
VHP-9000	4 mm Wrench	4 mm Hex	—	ea.
<b>EXTENDER TOOLS</b>				
Part No.	Description	Material		Qty.
P-291	Extender Tool for Standard Head Nuts, with 1/4" Hex Drive	Aluminum		ea.
P-298	Extender Tool for Standard Head Nuts	Delrin®		ea.
P-299	Extender Tool for Standard Head Nuts	Aluminum		ea.
P-399	Extender Tool for Standard Head Nuts, Short	Aluminum		ea.
P-297	Extender Tool for Headless Nuts	Aluminum		ea.
P-292	Extender Tool for Headless Nuts, with 1/4" Hex Drive	Aluminum		ea.
P-277	Extender Tool for Standard Micro Nuts	Aluminum		ea.
N-290	Extender Tool for Micro Headless Nuts	Aluminum		ea.
P-278	Extender Tool for Female Nuts, with 1/4" Hex Drive	Aluminum		ea.
<b>MISCELLANEOUS TOOLS</b>				
A-304	Wrench, 1/4" x 5/16"	Steel		ea.
A-305	Wrench, 1/2" x 9/16"	Steel		ea.
A-320	Wrench, 3/8" x 7/16"	Steel		ea.
6810	IDEX Wrench, 1/4" x 5/16"	Steel		ea.
F-345	FlushNut Wrench for 10-32 Threaded Fittings	Steel/Plastic Handle		ea.
F-346	FlushNut Wrench for 1/4-28 Threaded Fittings	Steel/Plastic Handle		ea.
LT-300	Removal Tool for LiteTouch and Super Flangeless Ferrules	Steel/Plastic Handle		ea.
M-150	Swaging Tool for TinyTight Fittings, for 6–40 MINSTAC Port	SST		ea.



# Tubing Sleeves

## MicroTight® Tubing Sleeves

- › Manufactured from PEEK polymer
- › Pressure rated to 4,000 psi (276 bar)
- › Color-coded for easy inner diameter identification

IDEX Health & Science MicroTight Tubing Sleeves feature an outer diameter of 0.025" and offer a wide assortment of inner diameters to help facilitate capillary tubing connections with our MicroTight accessories. Because the sleeves are manufactured from PEEK polymer, they carry an upper temperature threshold of 125 °C.

To use these sleeves properly, choose a sleeve with an inner diameter 0.001"–0.002" (25–50 µm) larger than the outer diameter of your capillary tubing. Then, slip the sleeve over your flow path tubing, such that your tubing extends all the way through the sleeve, but not beyond the end of the sleeve. Choose the correct fitting that corresponds with your receiving port, slide it over the sleeved flow path tubing and connect as normal.



## NanoTight™ Tubing Sleeves

- › Manufactured from FEP fluoropolymer
- › Pressure rated to 4,000 psi (276 bar)
- › Outer diameter of 1/16" — the most popular size used on most instrumentation

NanoTight Tubing Sleeves are manufactured using FEP fluoropolymer and precisely cut to a 1.6" length. A wide assortment of sleeves is available, ensuring the availability of a NanoTight sleeve for most applications. Many of the sleeves feature a light color tint that can help more easily identify the inner diameter for future orders. Because FEP is the base polymer for these sleeves, there is a maximum recommended continuous operating temperature of 50 °C.

Our NanoTight sleeves were designed primarily for use with the NanoTight fittings, found on page 37 and also work well with the Super Flangeless™ fittings for 1/16" OD tubing on page 39. For tubing sleeves that can be used effectively with stainless steel fittings and at higher temperatures, consider using the PEEK Tubing Sleeves, found below.

## 1/16" OD PEEK Tubing Sleeves

- › For connecting capillary tubing to standard 10-32 ports
- › Require the use of wrench tightened stainless steel nuts
- › Pressure rated to 6,000 psi (414 bar)



Like the NanoTight™ FEP Sleeves on the previous page, these PEEK Tubing Sleeves are designed to be used with 1/16" OD, 10-32 threaded fittings to adapt capillary tubing to standard coned ports. Made of PEEK polymer, these 1.3" long sleeves can be used up to 125 °C.

These sleeves require a wrench tightened nut to achieve proper sealing. We recommend our SealTight™ fittings on page 36. Many researchers also use a stainless steel nut and ferrule with these sleeves, such as our U-400 and U-401 (page 33).

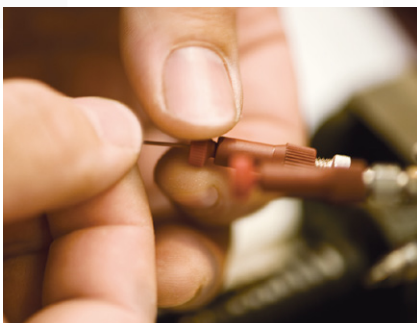

### 1/32" OD PEEK Tubing Sleeves

These 1.6" long 1/32" OD PEEK Tubing Sleeves can be used with any fitting designed for 1/32" OD tubing when smaller tubing must be connected. Select the appropriate sleeve from the product listing for your capillary tubing OD size. The 1/32" OD PEEK Tubing Sleeves have a maximum recommended temperature of 125 °C and have a pressure rating of 5,000 psi (345 bar).

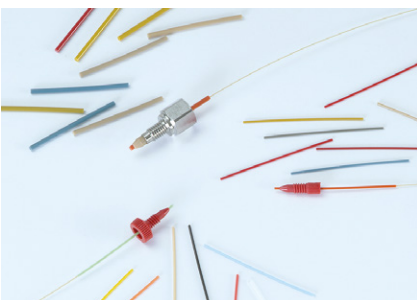

### 1/32" OD FEP Tubing Sleeves

These 1.6" long sleeves facilitate connecting capillary tubing into ports designed for 1/32" OD tubing. Please refer to the product listing below to select the appropriate sleeve for your capillary OD size. These sleeves can be used at up to 50 °C and have a pressure rating of 1,750 psi (121 bar).

Clockwise, starting at top:

- › 1/16" OD PEEK Tubing Sleeves, use with U-400 and U-401 (not shown)
- › 1/32" OD FEP Tubing Sleeves, shown with F-126Sx Fitting
- › Fittings and tubing only shown to highlight how sleeves are designed to be used; they are not included with the sleeves



## APPLICATION NOTE

### Why use Sleeves?

Because most capillary tubing connections are made into coned receiving ports, where the port is not designed to be used with capillary tubing directly, special care must be used to ensure a good connection. While custom ferrules can help make these connections, they only offer a fixed-length nose — and because most tubing pockets will vary slightly in length, this can lead to leaking or dead volume.

To help save overall expense while maintaining a concentric connection with minimal dead volume, IDEX Health & Science recommends the use of sleeves. Because sleeves are not permanently attached to a ferrule, they can easily adapt to varying tubing pocket depths. Additionally, because they are manufactured using extruded polymer tubing, you are assured of the concentricity of the resultant connection.

# Tubing Sleeves (Cont.)



## RELATED PRODUCTS

Use 1/32" OD PEEK or FEP Sleeves to connect capillary tubing with the following:

- › The F-113 Ferrule and Two-Piece Fingertight Fittings for 10-32 ports (page 35).
- › The F-112 and P-416BLK MicroTight® Fittings (page 34) — 1/32" OD PEEK Tubing Sleeves only.
- › The 1/32" OD MicroTight Fittings on page 34.
- › The RheFlex M4 Fitting (page 61) for MX Module applications; the M-645 Valco®-Compatible Fitting (page 33) for Valco Nanovolume® valve applications.

## Tubing Sleeves

Part No.	ID	For Tubing OD Size	Color	Qty.
<b>MICROTIGHT PEEK TUBING SLEEVES AND KITS, 0.025" OD</b>				
<b>F-180</b>	125 µm (0.005")	70–110 µm	Red	ea.
<b>F-181</b>	180 µm (0.007")	125–165 µm	Yellow	ea.
<b>F-182</b>	230 µm (0.009")	175–215 µm	Natural	ea.
<b>F-183</b>	280 µm (0.011")	225–265 µm	Blue	ea.
<b>F-184</b>	330 µm (0.013")	275–315 µm	Orange	ea.
<b>F-185</b>	395 µm (0.0155")	340–380 µm	Green	ea.
<b>F-186</b>	455 µm (0.018")	400–440 µm	Black	ea.
<b>F-187</b>	535 µm (0.021")	480–520 µm	Natural	ea.
<b>F-188</b>	152 µm (0.006")	95–135 µm	Purple	ea.
<b>1328</b>	MicroTight Tubing Sleeve Kit, contains (6) each of the sleeve sizes listed above	—	—	ea.
<b>1356</b>	MicroTight Connector Kit, contains: a 10-pack of each MicroTight Tubing Sleeve (F-180–F-187); (2) P-770 MicroTight Adapters; and (2) MicroTight P-720 Unions	—	—	ea.
<b>NANOTIGHT FEP TUBING SLEEVES, 1/16" OD</b>				
<b>F-237</b>	125 µm (0.005")	70–110 µm	Red	ea.
<b>F-238</b>	180 µm (0.007")	125–165 µm	Yellow	ea.
<b>F-239</b>	215 µm (0.0085")	160–200 µm	Natural	ea.
<b>F-240</b>	280 µm (0.011")	225–265 µm	Blue	ea.
<b>F-241</b>	330 µm (0.013")	275–315 µm	Orange	ea.
<b>F-242</b>	395 µm (0.0155")	340–380 µm	Green	ea.
<b>F-243</b>	455 µm (0.018")	400–440 µm	Black	ea.
<b>F-244</b>	535 µm (0.021")	480–520 µm	Natural	ea.
<b>F-245</b>	610 µm (0.024")	555–595 µm	Red	ea.
<b>F-246</b>	685 µm (0.027")	630–670 µm	Yellow	ea.
<b>F-247</b>	840 µm (0.033")	785–825 µm	Green	ea.
<b>F-252</b>	1.07 mm (0.042")	1 mm	Purple	ea.
<b>PEEK TUBING SLEEVES FOR 1/16" OD FITTINGS</b>				
<b>F-225</b>	125 µm (0.005")	70–110 µm	Red	ea.
<b>F-226</b>	180 µm (0.007")	125–165 µm	Yellow	ea.
<b>F-227</b>	230 µm (0.009")	175–215 µm	Yellow	ea.
<b>F-228</b>	250 µm (0.011")	225–265 µm	Blue	ea.
<b>F-229</b>	330 µm (0.013")	275–315 µm	Natural	ea.
<b>F-230</b>	405 µm (0.016")	350–390 µm	Orange	ea.
<b>F-231</b>	560 µm (0.022")	505–545 µm	Natural	ea.
<b>F-232</b>	785 µm (0.031")	730–770 µm	Natural	ea.
<b>F-233</b>	865 µm (0.034")	785–825 µm	Blue	ea.
<b>F-234</b>	685 µm (0.027")	630–670 µm	Yellow	ea.
<b>PEEK TUBING SLEEVES FOR 1/32" OD FITTINGS</b>				
<b>F-381</b>	180 µm (0.007")	125–165 µm	Yellow	ea.
<b>F-382</b>	205 µm (0.008")	150–190 µm	Natural	ea.
<b>F-384</b>	255 µm (0.010")	200–240 µm	Blue	ea.
<b>F-385</b>	380 µm (0.015")	325–365 µm	Natural	ea.
<b>F-386</b>	510 µm (0.020")	455–495 µm	Orange	ea.
<b>F-387</b>	250 µm (0.011")	225–265 µm	Red	ea.
<b>F-388</b>	330 µm (0.013")	275–315 µm	Black	ea.
<b>FEP TUBING SLEEVES FOR 1/32" OD FITTINGS</b>				
<b>F-374</b>	280 µm (0.011")	225–265 µm	Blue	ea.
<b>F-375</b>	330 µm (0.013")	275–315 µm	Orange	ea.
<b>F-376</b>	395 µm (0.0155")	340–380 µm	Green	ea.



# Plugs & Caps

- › Seal 6-32, 6-40, 10-32, 1/4-28, M6, or 5/16-24 threaded ports or fittings

Use our plugs to close off unused ports in valves and multi-port connectors. Our color-coded 10-32 threaded plugs are perfect for identifying stored columns that have different packing materials, or in which different mobile phases have been utilized. Cap off tubing with one of the PEEK or ETFE caps presented on this page and the appropriate fittings from this chapter.

To help determine which plug or cap is best suited for your application, please visit [www.idx-hs.com](http://www.idx-hs.com) for detailed chemical compatibility data.

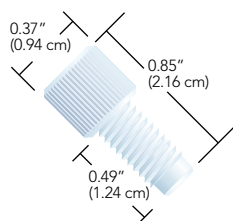

**P-316**  
PFA Plug  
for 1/4-28 flat-bottom ports

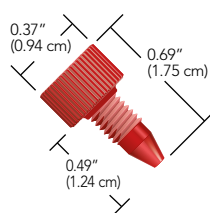

**U-467R**  
Delrin® Column Plug  
for 10-32 coned ports

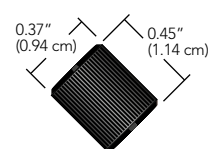

**P-755**  
ETFE Cap  
for 1/4-28 flat-bottom fittings

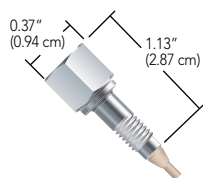

**VHP-600**  
VHP Plug  
for 10-32 coned ports

Part No.	Description	Head Style	Material	Qty.
<b>PLUGS</b>				
<b>P-120</b>	Plug for 1/4-28 Coned Ports for 1/8" OD Tubing	Standard Knurl	PCTFE Natural	ea.
<b>P-123</b>	Plug for 1/4-28 Flat-Bottom Ports	5/16" Hex	ETFE Natural	ea.
<b>P-309</b>	Plug for 1/4-28 Flat-Bottom Ports	Standard Knurl	Delrin Black	ea.
<b>P-311</b>	Plug for 1/4-28 Flat-Bottom Ports	Standard Knurl	ETFE Natural	ea.
<b>P-314</b>	Plug for M6 Flat-Bottom Ports	Standard Knurl	ETFE Black	ea.
<b>P-316</b>	Plug for 1/4-28 Flat-Bottom Ports	Standard Knurl	PFA Natural	ea.
<b>P-321</b>	Plug for 1/4-28 Flat-Bottom Ports, FlushNut™	FlushNut	PEEK Natural	ea.
<b>P-520</b>	Plug for 10-32 Coned Ports	5/16" Hex	SST	ea.
<b>P-550</b>	Plug for 10-32 Coned Ports, Extra Long	Standard Knurl	PEEK Natural	ea.
<b>P-551</b>	Plug for 10-32 Coned Ports	Standard Knurl	PEEK Natural	ea.
<b>P-555</b>	Plug for 6-32 Coned Ports	Standard Micro Knurl	PEEK Natural	ea.
<b>P-556</b>	Plug for 5/16-24 Flat-Bottom Ports	Standard Knurl	PEEK Natural	ea.
<b>P-558</b>	Plug for 6-40 Flat-Bottom Ports	Micro Headless Knurl	PEEK Green	ea.
<b>P-849</b>	Plug for 10-32 Flat-Bottom Ports	Standard Knurl	Delrin Black	ea.
<b>U-467R</b>	Plug for 10-32 Coned Ports	Standard Knurl	Delrin Red	ea.
<b>VHP-600</b>	VHP Plug for 10-32 Coned Ports	3/8" Hex	PK-SST	ea.
<b>CAPS</b>				
<b>P-754</b>	Cap for 10-32 Coned Ports	Standard Knurl	ETFE Yellow	ea.
<b>P-755</b>	Cap for 1/4-28 Flat-Bottom Ports	Standard Knurl	ETFE Black	ea.
<b>P-756</b>	Cap for M6 Flat-Bottom Ports	Standard Knurl	ETFE Blue	ea.



# Large Bore Fittings

- › 5/16-24 or 1/2-20 threads
- › For use with 1/16", 1/8", 3/16", 1/4", 5/16", 3.0 mm, or 4.0 mm OD tubing

## NOTE

Each of the Large Bore Fittings shown on this page comes in a convenient 10-pack and is packaged with the most popularly chosen Ferrule option. The Fittings can be ordered separately by removing the preceding letter "X" from the part number. Additionally, to connect metric-sized tubing with outer diameters less than 4.0 mm to 5/16-24 threaded ports, reference the chart on page 43 to choose the correct nut/ferrule combination.

## RELATED PRODUCTS

	Page
<b>MORE LARGE BORE PRODUCTS</b>	
5/16-24 Coned Fittings	41
Barbed Adapters	90
Threaded Adapters	63
Plugs	55, 112
Y Connector	90
ETFE Tubing	27
FEP, PFA Tubing	26, 24
Tubing Cutter	28
Pressure Relief Valve	148
Solvent Inlet Filters	102
Bottle Caps	55
Semi-Prep Inline Filters	107

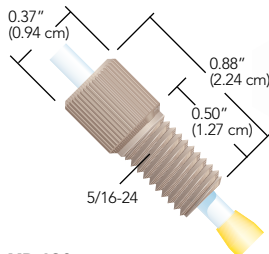

**XP-130x**  
PEEK Nut, for 1/8" OD tubing shown with P-300 Flangeless Ferrule (page 43)

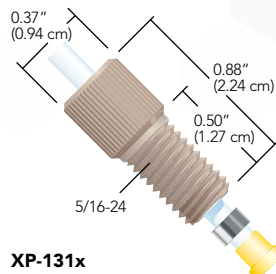

**XP-131x**  
PEEK Nut, for 1/8" OD tubing shown with P-359 Super Flangeless™ Ferrule (included and found on page 41)

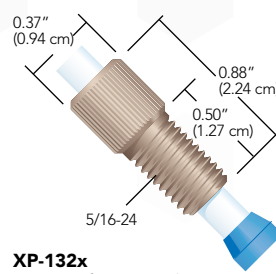

**XP-132x**  
PEEK Nut, for 3/16" and 4.0 mm OD tubing shown with P-133 Flangeless Ferrule (included and found on this page)

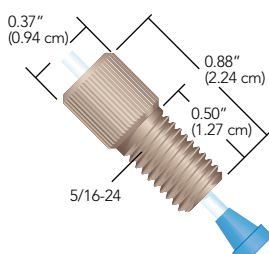

**XP-136x**  
PEEK Nut, for 1/16" OD tubing shown with P-200 Flangeless Ferrule (included and found on page 43)

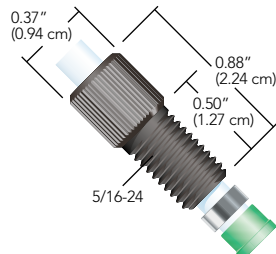

**XP-137x**  
PEEK Nut, for 3/16" OD tubing shown with P-140 Super Flangeless Ferrule (included and found on page 56)

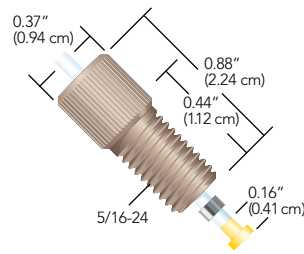

**XP-141x**  
PEEK Nut, for 1/16" OD tubing shown with P-259 Super Flangeless Ferrule (included and found on page 41)

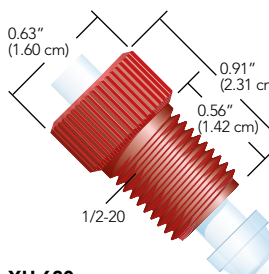

**XU-620x**  
PEEK Nut, for 1/4" OD tubing shown with inverted U-650 Flangeless Ferrule for coned ports (included and found on this page)

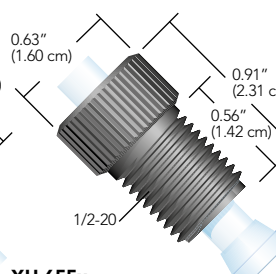

**XU-655x**  
PEEK Nut, for 1/4" OD tubing shown with U-650 Flangeless Ferrule (included and found on this page)

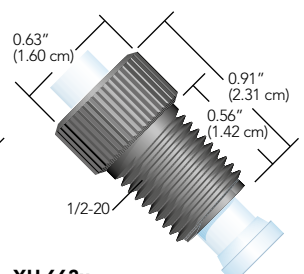

**XU-662x**  
PEEK Nut, for 5/16" OD tubing shown with U-660 Flangeless Ferrule (included and found on this page)

Part No.	Description	Port	Pressure Rating	Head Style	Material (Nut/Washer)	Qty.
<b>LARGE BORE FITTINGS</b>						
XP-130x	Flangeless Fitting for 1/8" OD tubing	5/16-24 Flat-Bottom	500 psi (34 bar)	Standard Knurl	PEEK Natural/ETFE Yellow	10-pk
XP-131x	Super Flangeless Fitting for 1/8" OD tubing	5/16-24 Flat-Bottom	1,000 psi (69 bar)	Standard Knurl	PEEK Natural/ETFE Yellow/SST	10-pk
XP-132x	Flangeless Fitting for 3/16" OD tubing	5/16-24 Flat-Bottom	500 psi (34 bar)	Standard Knurl	PEEK Natural/ETFE Blue	10-pk
XP-136x	Flangeless Fitting for 1/16" OD tubing	5/16-24 Flat-Bottom	2,000 psi (138 bar)	Standard Knurl	PEEK Natural/ETFE Blue	10-pk
XP-137x	Super Flangeless Fitting for 3/16" OD tubing	5/16-24 Flat-Bottom	500 psi (34 bar)	Standard Knurl	PEEK Black/ETFE Green/SST	10-pk
XP-141x	Super Flangeless Fitting for 1/16" OD tubing	5/16-24 Flat-Bottom	1,350 psi (93 bar)	Standard Knurl	PEEK Natural/ETFE Yellow/SST	10-pk
XU-620x	Flangeless Fitting for 1/4" OD tubing	1/2-20 Coned	250 psi (17 bar)	Large Knurl	PEEK Red/ETFE Natural	10-pk
XU-655x	Flangeless Fitting for 1/4" OD tubing	1/2-20 Flat-Bottom	250 psi (17 bar)	Large Knurl	PEEK Black/ETFE Natural	10-pk
XU-662x	Flangeless Fitting for 5/16" OD tubing	1/2-20 Flat-Bottom	250 psi (17 bar)	Large Knurl	PEEK Black/ETFE Natural	10-pk
<b>REPLACEMENT FERRULES</b>						
P-133x	Flangeless Ferrule for 3/16" OD tubing	5/16-24 Flat-Bottom	500 psi (34 bar)	—	ETFE Blue	10-pk
P-133Nx	Flangeless Ferrule for 3/16" OD tubing	5/16-24 Flat-Bottom	500 psi (34 bar)	—	ETFE Natural	10-pk
P-140x	Super Flangeless Ferrule for 3/16" OD tubing	5/16-24 Flat-Bottom	500 psi (34 bar)	—	ETFE Green	10-pk
U-650x	Flangeless Ferrule for 1/4" OD tubing	1/2-20 Flat-Bottom	250 psi (17 bar)	—	ETFE Natural	10-pk
U-660x	Flangeless Ferrule for 5/16" OD tubing	1/2-20 Flat-Bottom	250 psi (17 bar)	—	ETFE Natural	10-pk





# VHP Micro Fittings

Micro Fittings are specifically designed for use with microferrules. They are manufactured from a proprietary PEEK blend (PK) which allow them to be used at higher temperatures (up to 200° C) and higher pressures ideal for UHPLC applications.

VHP MicroFerrules and Fittings are made from a proprietary high performance PEEK polymer blend, a material which is unique in its ability to enable the use of capillary tubing in UHPLC environments. The new high pressure MicroFerrules are available for use with 1/32" or 360 µm OD tubing, and they are incorporated into several of our VHP products for capillary tubing.

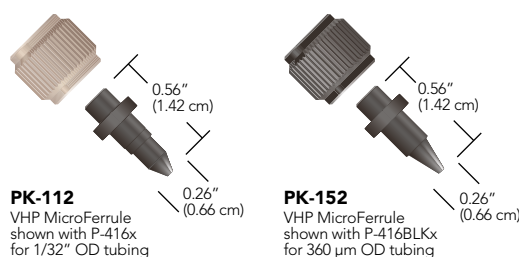

**PK-112**  
VHP MicroFerrule  
shown with P-416x  
for 1/32" OD tubing

**PK-152**  
VHP MicroFerrule  
shown with P-416BLKx  
for 360 µm OD tubing



## APPLICATION NOTE

Caution: While the proprietary blend of the PK fittings will allow a fitting to attain a higher pressure and minimal cold flow properties relative to pure PEEK, some fittings molded of PK are known to be conductive. Use caution when employing PK fittings in high voltage applications.



## NOTE

### MicroTight fittings and MicroFerrules

While the MicroTight Female Nuts may be used with any of the separate MicroFerrules, the MicroFerrules themselves are port-specific and are thus not interchangeable. Additionally, the one-piece MicroTight fittings are also port-specific and should not be exchanged.

Part No.	Description	Port	Pressure Rating	Required Torque	Head Style	Material	Qty.
<b>PK MICRO FERRULES AND FEMALE NUTS</b>							
<b>P-416</b>	Female Nut for Microferrule	5/16-24 Coned	15,000 psi (1,035 bar)	4.0 in-lbs (0.45 N-m)	Female Knurl	PEEK, Natural	ea.
<b>P-416BLK</b>	Female Nut for Microferrule	5/16-24 Coned	15,000 psi (1,035 bar)	4.0 in-lbs (0.45 N-m)	Female Knurl	PEEK, Black	ea.
<b>PK-112</b>	VHP MicroFerrule for 1/32" OD Tubing	5/16-24 Coned	15,000 psi (1,035 bar)	—	—	PK	ea.
<b>PK-152</b>	VHP MicroFerrule for 360 µm OD Tubing	5/16-24 Coned	15,000 psi (1,035 bar)	—	—	PK	ea.



# VHP PK Fittings



## RELATED PRODUCTS

- Find unions, tees and crosses for VHP applications on page 75, and 74.

Ultra High Performance fittings are manufactured from a proprietary PEEK blend (PK) which allow them to be used at higher temperatures (up to 200 °C) and higher pressures.

The VHP PK One-Piece fittings are available for 10-32 coned, 6-32 coned, or M4 coned ports, and Two-Piece fittings are available to connect either 1/16" or 1/32" OD tubing into 10-32 coned ports in multiple styles.

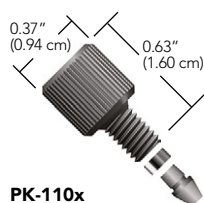

**PK-110x**  
10-32 PK Fitting  
shown with PK-100x for  
1/16" OD tubing



**PK-110x**  
10-32 PK Fitting  
shown with PK-132x for  
1/32" OD tubing

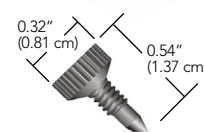

**PK-126x**  
6-32 PK MicroTight® Fitting  
for 1/32" OD tubing

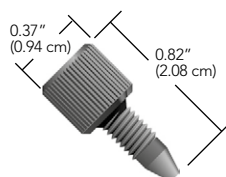

**PK-120BLKx**  
10-32 PK Fitting  
for 1/16" OD tubing

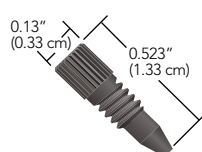

**PK-126Hx**  
6-32 PK MicroTight® Fitting  
for 1/32" OD tubing

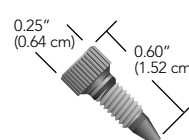

**UH-904x**  
M4, 1/32" Fitting  
for IDEX Health & Science  
MX valves

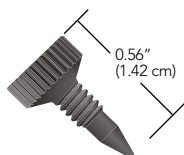

**PK-124x**  
6-32 PK MicroTight® Fitting  
for 1/32" OD tubing

Part No.	Description	Port	Pressure Rating	Required Torque	Head Style	Material	Qty.
<b>PK VHP ONE-PIECE FITTINGS</b>							
<b>PK-120BLKx</b>	PK One-Piece Fitting for 1/16" OD Tubing	10-32 Coned	12,000 psi (827 bar)	8.0 in-lbs (0.90 N-m)	Standard Knurl	PK	10-pk
<b>PK-126Hx</b>	PK One-Piece Headless Fitting for 1/32" OD Tubing	6-32 Coned	15,000 psi (1,035 bar)	3.0 in-lbs (0.34 N-m)	Headless Micro Knurl	PK	10-pk
<b>PK-126x</b>	PK One-Piece Fitting for 1/32" OD Tubing	6-32 Coned	15,000 psi (1,035 bar)	3.0 in-lbs (0.34 N-m)	Standard Micro Knurl	PK	10-pk
<b>UH-904x</b>	PK One-Piece Fitting for 1/32" OD Tubing	M4 Coned	15,000 psi (1,035 bar)	4.0 in-lbs (0.45 N-m)	Headless Knurl	PK	10-pk
<b>PK VHP FITTINGS (LITETOUCH® STYLE, NUTS AND FERRULES SOLD SEPARATELY)</b>							
<b>PK-100x</b>	PK Ferrule for 1/16" OD Tubing	10-32 Coned	16,500 psi (1,140 bar)	—	—	PK	10-pk
<b>PK-110x</b>	PK Nut for 1/16" OD Tubing	10-32 Coned	16,500 psi (1,140 bar)	8.0 in-lbs (0.90 N-m)	Standard Knurl	PK	10-pk
<b>PK-132x</b>	PK Ferrule for 1/32" OD Tubing	10-32 Coned	16,500 psi (1,140 bar)	—	—	PK	10-pk

# Stainless Steel VHP Fittings

- › Pressure rated to 30,000 psi (2,070 bar)
- › Double compression ferrule design
- › Available with 10-32 threads for 1/16" OD tubing and M4 threads for 1/32" OD tubing

The all Stainless-Steel VHP Fittings include a unique ferrule system with two compression points to provide twice the grip of a standard ferrule. This design also allows the bite on the tubing to be less concentrated and does not restrict the inner diameter, as discussed in the Application Note. The ferrules for 1/16" OD tubing and 10-32 coned ports are two pieces, while the grooved ferrule for 1/32" OD tubing and M4 coned ports is a one-piece design for easier handling, but it will act as two pieces with double compression on the tubing as it is tightened down.



## APPLICATION NOTE

In order to seal up to the stated pressure rating, the VHP-200-01 ferrule requires 20 in-lbs (2.25 N·m) of torque. Similar ferrules on the market require tightening torque of at least 30 in-lbs (3.3 N·m), which can result in a restricted tubing passage, as shown in the picture below. This restriction can increase turbulence and add a 'throttling' effect to the fluid pathway, resulting in mixing and other potential chromatographic problems.

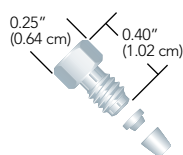

**VHP-200x**  
VHP 10-32 Fitting  
for 1/16" OD tubing

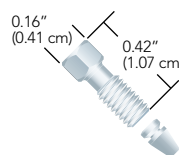

**VHP-700x**  
VHP 6-40 Fitting  
for 1/32" OD tubing

**IDEX Health & Science**  
**VHP-200**

**Conventional Two**  
**Piece Ferrule Design**

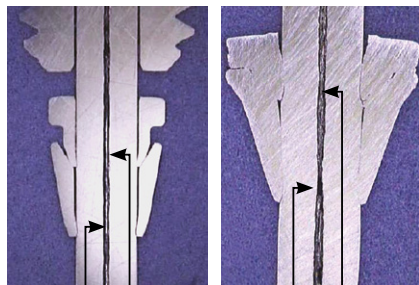

Uniform  
Tubing Passage

Constricted  
Tubing Passage

Part No.	Description	Port	Pressure Rating	Required Torque	Head Style	Material	Qty.
<b>STAINLESS STEEL VHP FITTINGS (INCLUDES NUT AND FERRULE)</b>							
<b>VHP-200x</b>	VHP Fitting for 1/16" OD	10-32 Coned	30,000 psi (2,070 bar)	20 in-lbs (2.25 N·m)	1/4" Hex	SST	10-pk
<b>VHP-700x</b>	VHP Fitting for 1/32" OD	6-40 Coned	30,000 psi (2,070 bar)	20 in-lbs (2.25 N·m)	4 mm Hex	SST	10-pk
<b>STAINLESS STEEL VHP FERRULES</b>							
<b>VHP-200-01x</b>	VHP Ferrule for 1/16" OD	10-32 Coned	30,000 psi (2,070 bar)	20 in-lbs (2.25 N·m)	—	SST	10-pk



# Reusable VHP Fittings

- › Pressure rated up to 25,000 psi (1,720 bar)
- › Patented innovative design
- › Capable of up to ten repeat assembly cycles with no impact on pressure holding ability or carry-over
- › Available in 10-32 threads for 1/16" OD tubing and M4 threads for 1/32" OD tubing
- › Materials of construction: stainless steel and proprietary PEEK polymer blend (PK)
- › Quick component replacement, minimal downtime



## RELATED PRODUCTS

- › Find tightening tools on page 50 designed to deliver the torque necessary for these fittings.

IDEX Health & Science introduces an innovative line of Very High Pressure (VHP) fittings, designed to withstand extreme pressures. This patented line of ground-breaking fitting systems is perfect for use within the increasingly demanding requirements of today's high performance analytical systems.

The Reusable VHP fittings can be reused when following the tightening torque specification listed below. With a polymer front ferrule, there is no damage to the tubing or receiving port, also increasing the life of these components.

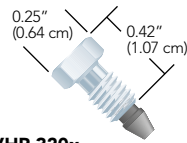

**VHP-320x**  
10-32 VHP Fitting  
for 1/16" OD tubing

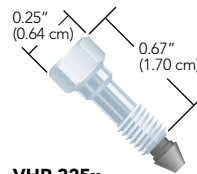

**VHP-325x**  
10-32 VHP Fitting, Long  
for 1/16" OD tubing

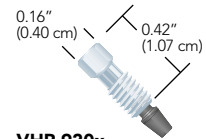

**VHP-920x**  
M4 VHP Fitting  
for 1/32" OD tubing

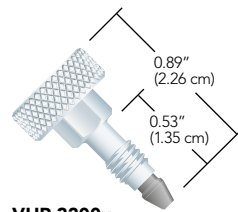

**VHP-3200x**  
10-32 VHP Fitting  
for 1/16" OD tubing

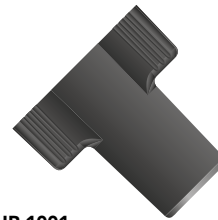

**VHP-1001**  
VHP Fingertight  
1/4" Hex Tool

Part No.	Description	Port	Pressure Rating	Required Torque	Head Style	Material	Qty.
<b>REUSABLE VHP FITTINGS</b>							
<b>VHP-320x</b>	VHP Fitting for 1/16" OD	10-32 Coned	25,000 psi (1,720 bar)	10 in-lbs (1.10 N-m)	1/4" Hex	SST/PK	10-pk
<b>VHP-325x</b>	VHP Fitting for 1/16" OD, Long	10-32 Coned	25,000 psi (1,720 bar)	10 in-lbs (1.10 N-m)	1/4" Hex	SST/PK	10-pk
<b>VHP-920x</b>	VHP Fitting for 1/32" OD	M4 Coned	25,000 psi (1,720 bar)	8 in-lbs (0.90 N-m)	4 mm Hex	SST/PK	10-pk
<b>VHP-3200x</b>	VHP Fitting for 1/16" OD	10-32 Coned	11,000 psi (760 bar)	3.5 in-lbs (0.40 N-m)	1/2" Knurl	SST/PK	10-pk
<b>VHP-1001</b>	VHP Fingertight 1/4" Hex Tool	—	—	—	—	PPS	ea.

# Assorted Fittings Kits

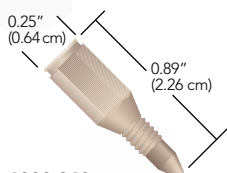
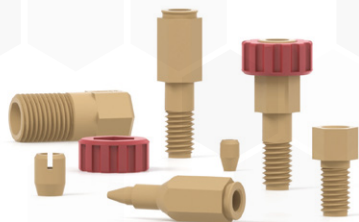

**6000-360**  
M4 Fitting  
M4 threads  
for 1/32" OD tubing

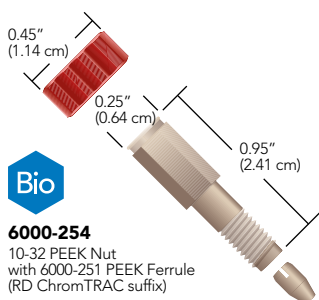

**6000-254**  
10-32 PEEK Nut  
with 6000-251 PEEK Ferrule  
(RD ChromTRAC suffix)

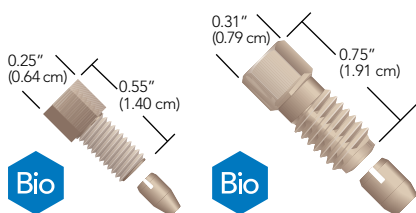

**6000-255**  
10-32 PEEK Nut  
with 6000-251 PEEK Ferrule

**6000-078**  
5/16-24 PEEK Nut  
with 6000-079 PEEK Ferrule

## RheFlex® M4 Fittings

- › Incorporates M4 coned threads for 1/32" OD tubing
- › Pressure rated to 5,000 psi (345 bar)

Our RheFlex M4 Fitting is designed to connect 1/32" OD tubing in MX Series II™ valves (see Actuated Valves, starting on page 119). This PEEK fitting has a one piece design, which eliminates the need for a separate nut and ferrule. The M4 Fitting design provides dependable zero dead volume connections for micro and nano applications. Due to the unique RheFlex gripping design, the M4 Fitting will hold to 5,000 psi (345 bar) on PEEK or with a PEEK tubing sleeve on fused silica tubing. A PEEK M4 Plug is also available.

Use ChromTRAC™ knobs with the RheFlex M4 Fitting for fingertight convenience and to color-code connections.

## Two-Piece RheFlex Fingertight Fittings

The RheFlex Precision Two-Piece PEEK Fittings sets provide inert, biocompatible connections for instrumentation. These fittings have a reliable, time-tested design. Each 1/16" fittings set contains a 10-32 threaded nut and a specially-designed PEEK ferrule. Three lengths of the 1/16" nut are available: Standard, Short, and Extra Long. RheFlex Fingertight Fittings are rated for use up to 7,000 psi (483 bar). Also offered in this product line is the 6000-078 fitting, designed to connect 1/8" OD tubing into our manual preparative-scale injection valves. (See page 115 for more information on these valves.) *View the online product bulletin at: [www.idex-hs.com](http://www.idex-hs.com).*

## ChromTRAC™

- › Brightly colored knobs to easily track inlets and outlets of valves, columns, and detectors

All ChromTRAC-compatible RheFlex fittings offer the ChromTRAC knob option. Specify the ChromTRAC two letter suffix for the color choice when ordering. Please see the ChromTRAC Suffix Codes table below. For example, to order red ChromTRAC knobs with the RheFlex One-Piece Fitting on this page, specify 6000-282RD. No suffix indicates black knobs. *View the online product bulletin for RheFlex fittings at: [www.idex-hs.com](http://www.idex-hs.com).*

### ChromTRAC Suffix Codes

CODE	COLOR	CODE	COLOR
BL	Blue	WH	White
GN	Green	YL	Yellow
GY	Gray	MC	Multi-color (two each of blue, green, gray, red, and yellow)
RD	Red		

Add these letter suffixes to the end of the seven-digit part numbers of the 10-32 and M4 threaded RheFlex Fittings listed below.

## RELATED PRODUCTS

- › For PEEK tubing sleeves that can be used with these M4 RheFlex fittings, see page 52.
- › For reusable fittings that both work in UHPLC applications and can help ensure the tubing is fully inserted into the receiving port, see page 60.

Part No.	Description	Port	Pressure Rating	Head Style	Material	Qty.
<b>RHEFLEX ONE-PIECE FITTINGS</b>						
<b>6000-360</b>	RheFlex Fitting for 1/32" OD Tubing	M4 Coned	5,000 (345 bar)	1/4" Hex	PEEK, Natural	10-pk
<b>RHEFLEX TWO-PIECE FITTINGS (INCLUDES FERRULES)</b>						
<b>6000-078</b>	RheFlex Fitting for 1/8" OD Tubing	5/16-24 Coned	5,000 psi (345 bar)	5/16" Hex	PEEK, Natural	ea.
<b>6000-254</b>	RheFlex Fitting for 1/16" OD Tubing	10-32 Coned	7,000 psi (483 bar)	ChromTRAC knob	PEEK, Natural	10-pk
<b>6000-255</b>	RheFlex Fitting for 1/16" OD Tubing, Short	10-32 Coned	7,000 psi (483 bar)	1/4" Hex	PEEK, Natural	10-pk
<b>REPLACEMENT FERRULES</b>						
<b>6000-079</b>	RheFlex Ferrule for 1/8" OD Tubing	5/16-24 Coned	7,000 psi (483 bar)	ChromTRAC knob	PEEK, Natural	5-pk
<b>6000-251</b>	RheFlex Ferrule for 1/16" OD Tubing	10-32 Coned	7,000 psi (483 bar)	ChromTRAC knob	PEEK, Natural	10-pk